



## MODEL

OL-HRN-RS-NI4

## GUIDE ID

NI4\_AL-XX70-B\_RS-X70\_20230607

## AVAILABLE ACCESSORIES

OL-HRN-RS-PWR

(Adapt to any brand remote start w/ BLADE or OL-MDB-ALL / FL-CAN / ADS-AL-CA)

## VEHICLE COMPATIBILITY

For AL-XX70-B installations see pages 5-24  
For RS-X70 installations see pages 25-44

Make	Model	Trim	Years	Firmware	Diagram
Chevrolet	City Express	Std. Key Automatic	2015 - 2018	DL-NI4	2
Infiniti	QX56	Std. Key Automatic (w/o alarm)	2005 - 2009	DL-NI4	1
Infiniti	QX56	Std. Key Automatic (w/ alarm)	2005 - 2009	DL-NI4	2
Infiniti	QX56	W/ Intelli-Key Automatic	2008 - 2010	DL-NI4	3
Nissan	350Z	Std. Key Automatic (w/o alarm)	2006 - 2009	DL-NI4	1
Nissan	350Z	Std. Key Automatic (w/ alarm)	2006 - 2009	DL-NI4	2
Nissan	Altima	Std. Key Automatic (w/o alarm)	2005 - 2006	DL-NI4	1
Nissan	Altima	Std. Key Manual (w/o alarm)	2005 - 2006	DL-NI4	4
Nissan	Altima	Std. Key Automatic (w/ alarm)	2005 - 2006	DL-NI4	2
Nissan	Altima	Std. Key Manual (w/ alarm)	2005 - 2006	DL-NI4	5
Nissan	Armada	Std. Key Automatic (w/o alarm)	2005 - 2015	DL-NI4	1
Nissan	Armada	Std. Key Automatic (w/ alarm)	2005 - 2015	DL-NI4	2
Nissan	Armada	W/ Intelli-Key Automatic	2008 - 2015	DL-NI4	3
Nissan	Cube	Std. Key Automatic (w/o alarm)	2009 - 2014	DL-NI4	1

**DISCLAIMER:** The manufacturer of this product nor its affiliates accept any responsibility for any electrical damage to the vehicle or any other connected systems as a result of improper installation of this product. All wiring connections & vehicle compatibility must be verified by a professionally qualified technician prior to installation.

## VEHICLE COMPATIBILITY (cont.)

Make	Model	Trim	Years	Firmware	Diagram
Nissan	Cube	Std. Key Manual (w/o alarm)	2009 - 2014	DL-NI4	4
Nissan	Cube	Std. Key Automatic (w/ alarm)	2009 - 2014	DL-NI4	2
Nissan	Frontier	Std. Key Automatic (w/o alarm)	2005 - 2019	DL-NI4	1
Nissan	Frontier	Std. Key Manual (w/o alarm)	2005 - 2019	DL-NI4	4
Nissan	Frontier	Std. Key Automatic (w/ alarm)	2005 - 2019	DL-NI4	2
Nissan	Frontier	Std. Key Manual (w/ alarm)	2005 - 2019	DL-NI4	5
Nissan	Juke	Std. Key Automatic (w/o alarm)	2011 - 2017	DL-NI4	1
Nissan	Juke	Std. Key Manual (w/o alarm)	2011 - 2017	DL-NI4	4
Nissan	Juke	Std. Key Automatic (w/ alarm)	2011 - 2017	DL-NI4	2
Nissan	Juke	Std. Key Manual (w/ alarm)	2011 - 2017	DL-NI4	5
Nissan	Maxima	Std. Key Automatic (w/o alarm)	2004 - 2008	DL-NI4	1
Nissan	Maxima	Std. Key Manual (w/o alarm)	2004 - 2006	DL-NI4	4
Nissan	Maxima	Std. Key Automatic (w/ alarm)	2004 - 2008	DL-NI4	2
Nissan	Maxima	Std. Key Manual (w/ alarm)	2004 - 2006	DL-NI4	5
Nissan	Maxima	W/ Intelli-Key Automatic	2007 - 2008	DL-NI4	3
Nissan	Micra	Std. Key Automatic	2015 - 2019	DL-NI4	2
Nissan	Micra	Std. Key Manual	2015 - 2019	DL-NI4	5
Nissan	NV 200	Std. Key Automatic (w/o alarm)	2013 - 2021	DL-NI4	2
Nissan	NV 1500	Std. Key Automatic (w/o alarm)	2012 - 2021	DL-NI4	2
Nissan	NV 2500	Std. Key Automatic (w/o alarm)	2012 - 2021	DL-NI4	2
Nissan	NV 3500	Std. Key Automatic (w/o alarm)	2012 - 2021	DL-NI4	2
Nissan	Pathfinder	Std. Key Automatic (w/o alarm)	2005 - 2012	DL-NI4	1
Nissan	Pathfinder	Std. Key Automatic (w/ alarm)	2005 - 2012	DL-NI4	2
Nissan	Pathfinder	W/ Intelli-Key Automatic	2008 - 2012	DL-NI4	3
Nissan	Quest	Std. Key Automatic (w/o alarm)	2004 - 2009	DL-NI4	1
Nissan	Quest	Std. Key Automatic (w/ alarm)	2004 - 2009	DL-NI4	2
Nissan	Rogue	Std. Key Automatic (w/o alarm)	2008 - 2013	DL-NI4	1
Nissan	Rogue	Std. Key Automatic (w/ alarm)	2008 - 2013	DL-NI4	2
Nissan	Rogue	W/ Intelli-Key Automatic	2008 - 2013	DL-NI4	3

**VEHICLE COMPATIBILITY (cont.)**

Make	Model	Trim	Years	Firmware	Diagram
Nissan	Rogue Select	Std. Key Automatic (w/o alarm)	2014 - 2015	DL-NI4	1
Nissan	Rogue Select	W/ Intelli-Key Automatic	2014 - 2015	DL-NI4	3
Nissan	Sentra	Std. Key Automatic (w/o alarm)	2007 - 2012	DL-NI4	1
Nissan	Sentra	Std. Key Manual (w/o alarm)	2007 - 2012	DL-NI4	4
Nissan	Sentra	Std. Key Automatic (w/ alarm)	2007 - 2012	DL-NI4	2
Nissan	Sentra	Std. Key Manual (w/ alarm)	2007 - 2012	DL-NI4	5
Nissan	Sentra	W/ Intelli-Key Automatic	2007 - 2012	DL-NI4	3
Nissan	Sentra	Std. Key Automatic	2013 - 2019	DL-NI4	2
Nissan	Sentra	Std. Key Manual	2013 - 2019	DL-NI4	5
Nissan	Titan	Std. Key Automatic (w/o alarm)	2005 - 2015	DL-NI4	1
Nissan	Titan	Std. Key Automatic (w/ alarm)	2005 - 2015	DL-NI4	2
Nissan	Versa	Std. Key Automatic (w/o alarm)	2007 - 2019	DL-NI4	1
Nissan	Versa	Std. Key Manual (w/o alarm)	2007 - 2019	DL-NI4	4
Nissan	Versa	Std. Key Automatic (w/ alarm)	2007 - 2019	DL-NI4	2
Nissan	Versa	Std. Key Manual (w/ alarm)	2013 - 2019	DL-NI4	5
Nissan	Versa	W/ Intelli-Key Automatic	2007 - 2011	DL-NI4	3
Nissan	Versa	W/ Intelli-Key Manual	2007 - 2011	DL-NI4	6
Nissan	Versa Note	Std. Key Automatic	2014 - 2019	DL-NI4	2
Nissan	Versa Note	Std. Key Manual	2014 - 2019	DL-NI4	5
Nissan	Xterra	Std. Key Automatic (w/o alarm)	2005 - 2015	DL-NI4	1
Nissan	Xterra	Std. Key Manual (w/o alarm)	2005 - 2015	DL-NI4	4
Nissan	Xterra	Std. Key Automatic (w/ alarm)	2005 - 2015	DL-NI4	2
Nissan	Xterra	Std. Key Manual (w/ alarm)	2005 - 2015	DL-NI4	5
Suzuki	Equator	Std. Key Automatic (w/o alarm)	2009 - 2011	DL-NI4	1
Suzuki	Equator	Std. Key Manual (w/o alarm)	2009 - 2011	DL-NI4	4
Suzuki	Equator	Std. Key Automatic (w/ alarm)	2009 - 2011	DL-NI4	2
Suzuki	Equator	Std. Key Manual (w/ alarm)	2009 - 2011	DL-NI4	5

## INSTALLTION NOTES

### Vehicles Equipped w/ Hill Start Assist

Use Red & Blue wires in harness and wire relay as shown to power 2<sup>nd</sup> accessory and prevent the Hill Assist Light from flashing during remote start.

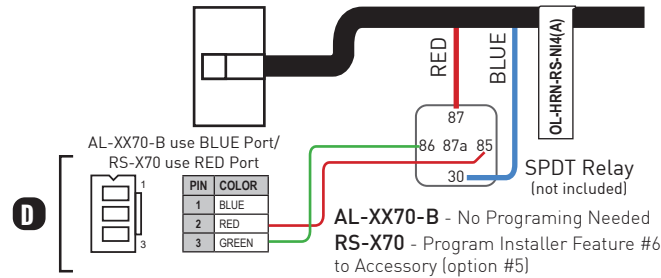

### Insert Pin

On some vehicles the Lock/Arm & Unlock/Disarm inputs to the BCM are not populated.

In these applications the output from the remote start system can be inserted into the empty locations listed to control the Lock/Arm & Unlock/Disarm operation.

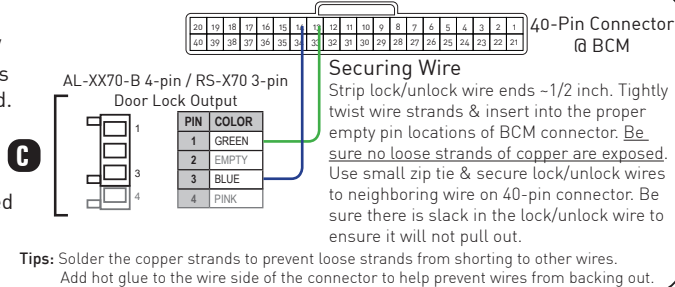

**AL-XX70-B Layout**

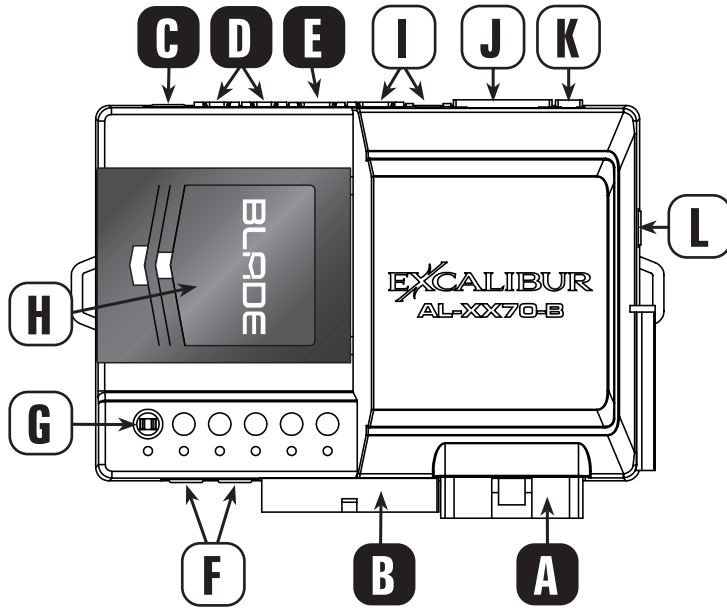

- A** WHITE 6 PIN HIGH CURRENT POWER HARNESS (P/N: H-RS6E\*)
- B** WHITE 18 PIN MAIN INPUT/OUTPUT HARNESS (P/N: H-RS18A)
- C** RED 4 PIN DOOR LOCK/UNLOCK HARNESS (P/N: DLP-N4)
- D** RED 3 PIN REMOTE START HARNESS (P/N: RS-OUTPUT)
- E** WHITE 4 PIN AUXILIARY HARNESS (P/N: H-RS4)
- F** WHITE 4 PIN PLUG-IN SENSOR PORTS (harness included w/ optional sensors)
- G** TEMPERATURE SENSOR - **DO NOT COVER**  
(For high/low temp auto start and for automatic low temp crank extender)
- H** BLADE CARTRIDGE PORT - For OL-BLADE-AL64 or OL-BLADE-TB
- I** GREEN & BLACK DATA PORTS - For Telematics / Data Sensor (Shock, Tilt, etc) / Vehicle Interface Module.  
(DBI & iDataLink protocols supported on both ports - see 'Vehicle Learn' or installer feature #12)
- J** BLADE HARNESS PORT - Use harness from BLADE or an 'OL-HRN-RS' T-Harness.
- K** ANTENNA / STATUS LIGHT / VALET PORT - Supports compatible plug-in antennas or push-button status light  
(P/N: AU-LED-PB2)
- L** BACKUP BATTERY PORT - Uses standard 9v battery with bracket & plug. Featuring PowerMaze technology - only supports security critical functions!

**AL-XX70-B Installation Steps**

**INSTALLATION STEPS:**

- 1) Go to [OmegaWeblink.com](http://OmegaWeblink.com) or use WebLink Mobile to flash the OL-BLADE-AL64 with the firmware matching the vehicle.  
NOTE: If OEM remote is being used to activate the remote start be sure to enable "Factory keyless RS sequence" as "Lock + Lock + Lock" OR "Lock + Unlock + Lock"
- 2) While at [OmegaWeblink.com](http://OmegaWeblink.com), make sure the AL-XX70-B is updated to v1.5 FW or higher.
- 3) Make all the connections shown in the diagram on the following pages.
- 4) Connect any optional hardware as needed.
- 5) Program the OL-BLADE-AL64 to the vehicle (see "BLADE Programming" on the following pages).
- 6) Perform Vehicle Learn to configure the remote start to match the vehicle (see "AL-XX70-B Programming/Vehicle Learn" on the following pages).  
NOTE: If Vehicle Learn is not performed remote start operation could fail.
- 7) Test the system for all desired functions.

NOTE: Any features NOT supported by the interface module must be hard wired from the remote start to the vehicle. Refer to the remote start install guide and vehicle wiring info at [www.wiresheet.com](http://www.wiresheet.com) (only available for authorized dealers) for instructions.

## MODEL: OL-HRN-RS-NI4

### Wire Location Chart Diagram #1

Make	Model	Trim	Year	Item	Connector Color	Connector Pins	Pin #	Wire Color	Polarity	Location
Infiniti	QX56	Std. Key Automatic (w/o alarm)	2005 - 2009	Parking Lights	White	24	12	RED/BLUE	(+)	Drivers Kick Panel
				Horn Honk	GRAY	8	2	RED/WHITE	(-)	Horn Switch Top of Steering Column
Nissan	350Z	Std. Key Automatic (w/o alarm)	2006 - 2009	Parking Lights	-	-	-	RED/BLUE	(+)	Drivers Kick Panel
				Horn Honk	GRAY	8	2	GREEN/BLACK	(-)	Horn Switch Top of Steering Column
Nissan	Altima	Std. Key Automatic (w/o alarm)	2005 - 2006	Parking Lights	-	-	-	RED/BLUE	(+)	Drivers Kick Panel
				Horn Honk	-	-	-	GREEN/WHITE	(-)	Horn Switch Top of Steering Column
Nissan	Armada	Std. Key Automatic (w/o alarm)	2005 - 2015	Parking Lights	White	24	12	RED/BLUE	(+)	Drivers Kick Panel
				Horn Honk	GRAY	8	2	RED/WHITE	(-)	Horn Switch Top of Steering Column
Nissan	Cube	Std. Key Automatic (w/o alarm)	2009 - 2014	Parking Lights	WHITE	16	13	BROWN/WHITE	(+)	Drivers Kick Panel
				Horn Honk	-	-	-	RED/BLACK	(-)	Horn Switch Top of Steering Column
Nissan	Frontier	Std. Key Automatic (w/o alarm)	2005 - 2019	Parking Lights	WHITE	6	4	RED	(+)	Electric Brake Plug Behind OBDII Plug
				Horn Honk	-	-	-	BROWN or RED	(-)	Horn Switch Top of Steering Column
Nissan	Juke	Std. Key Automatic (w/o alarm)	2011 - 2017	Parking Lights	WHITE	100	70	VIOLET	(+)	Drivers Kick Panel
				Horn Honk	GRAY	8	8	RED or LT. GREEN	(-)	Horn Switch Top of Steering Column
Nissan	Maxima	Std. Key Automatic (w/o alarm)	2007 - 2008	Parking Lights	-	-	-	RED/BLUE	(+)	Drivers Kick Panel
				Horn Honk	GRAY	8	2	RED	(-)	Horn Switch Top of Steering Column
Nissan	Maxima	Std. Key Automatic (w/o alarm)	2004 - 2006	Parking Lights	-	-	-	RED/BLUE	(+)	Drivers Kick Panel
				Horn Honk	GRAY	8	2	GREEN/WHITE	(-)	Horn Switch Top of Steering Column
Nissan	Pathfinder	Std. Key Automatic (w/o alarm)	2005 - 2012	Parking Lights	GRAY	8	1	GRAY	(+)	Drivers Kick Panel
				Horn Honk	WHITE	16	9	BROWN	(-)	Drivers Kick Panel
Nissan	Quest	Std. Key Automatic (w/o alarm)	2004 - 2009	Parking Lights	-	-	-	RED/BLUE	(+)	Drivers Kick Panel
				Horn Honk	-	-	-	GREEN/WHITE	(-)	Horn Switch Top of Steering Column
Nissan	Rogue	Std. Key Automatic (w/o alarm)	2008 - 2013	Parking Lights	-	-	-	RED	(+)	Drivers Kick Panel
				Horn Honk	-	-	-	GRAY	(-)	Horn Switch Top of Steering Column
Nissan	Rogue Select	Std. Key Automatic (w/o alarm)	2014 - 2015	Parking Lights	-	-	-	RED	(+)	Drivers Kick Panel
				Horn Honk	-	-	-	GRAY	(-)	Horn Switch Top of Steering Column
Nissan	Sentra	Std. Key Automatic (w/o alarm)	2007 - 2012	Parking Lights	GRAY	16	4	RED	(+)	Right Side Of Fuse Box
				Horn Honk	GRAY	8	3	GREEN	(-)	Horn Switch Top of Steering Column
Nissan	Titan	Std. Key Automatic (w/o alarm)	2005 - 2015	Parking Lights	WHITE	6	4	RED/BLUE	(+)	Electric Brake Plug Left Of Column
				Horn Honk	GRAY	8	2	RED/WHITE	(-)	Horn Switch Top of Steering Column
Nissan	Versa	Std. Key Automatic (w/o alarm)	2007 - 2019	Parking Lights	GRAY	16	4	RED	(+)	Drivers Kick Panel
				Horn Honk	GRAY	8	5	RED	(-)	Horn Switch Top of Steering Column

**Wire Location Chart Diagram #1**

Make	Model	Trim	Year	Item	Connector Color	Connector Pins	Pin #	Wire Color	Polarity	Location
Nissan	Xterra	Std. Key Automatic (w/o alarm)	2005 - 2015	Parking Lights	GRAY	8	1	GRAY	(+)	Drivers Kick Panel
				Horn Honk	WHITE	16	9	BROWN	(-)	Drivers Kick Panel
Suzuki	Equator	Std. Key Automatic (w/o alarm)	2009 - 2011	Parking Lights	GRAY	8	1	GRAY	(+)	Drivers Kick Panel
				Horn Honk	WHITE	16	9	BROWN	(-)	Drivers Kick Panel

## MODEL: OL-HRN-RS-NI4

### AL-XX70-B Diagram #1

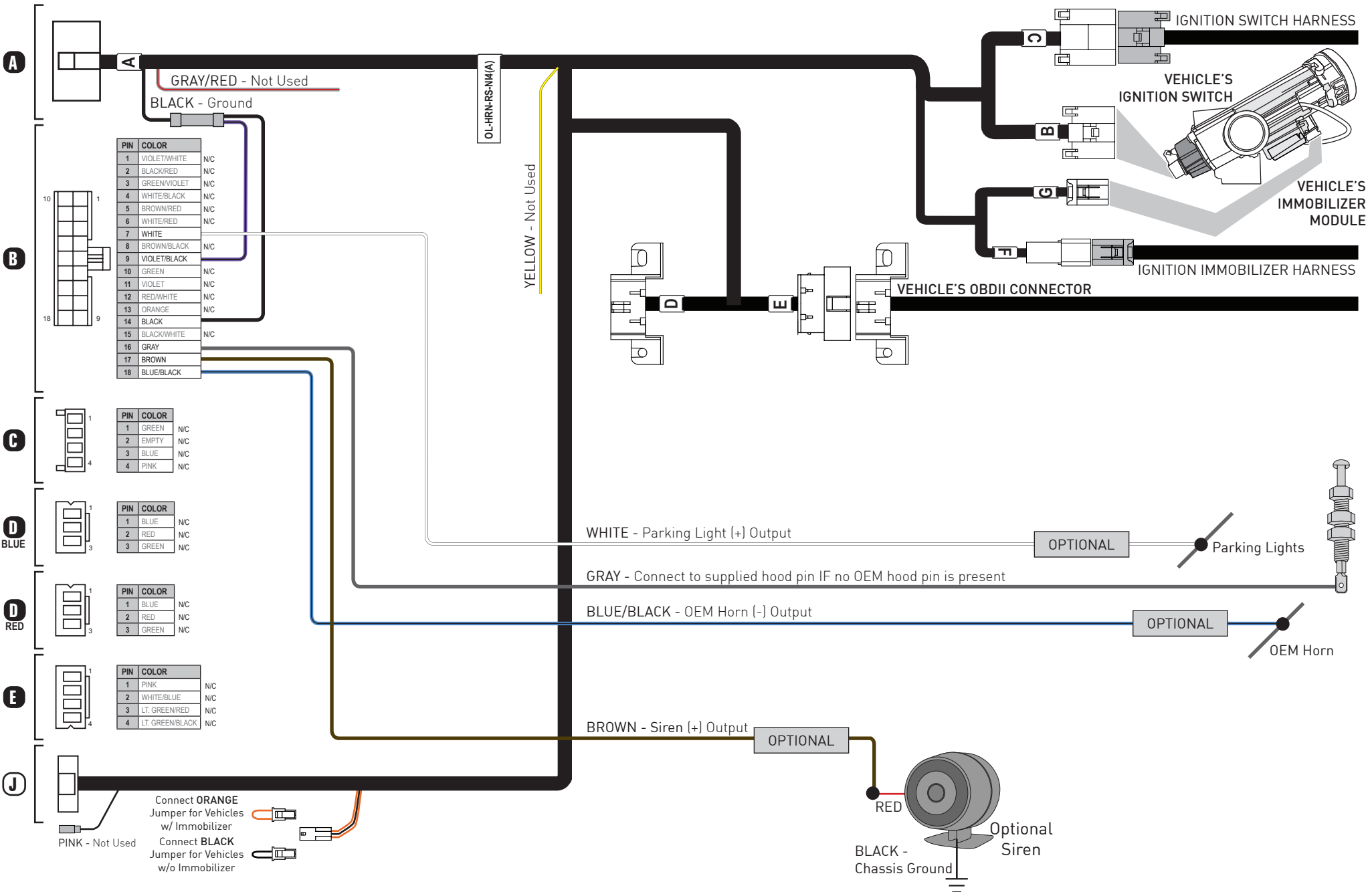

## MODEL: OL-HRN-RS-NI4

### Wire Location Chart Diagram #2

Make	Model	Trim	Year	Item	Connector Color	Connector Pins	Pin #	Wire Color	Polarity	Location
Chevrolet	City Express	Std. Key Automatic	2015 - 2018	OEM Arm/Lock	WHITE	12	4	PINK	(-)	Drivers Kick Harness From Door
				OEM Disarm/Unlock	WHITE	12	7	BLACK	(-)	Drivers Kick Harness From Door
				Parking Lights	-	-	-	VIOLET	(+)	Drivers Firewall Harness
				Horn Honk	GRAY	8	5	RED	(-)	Horn Switch Top of Steering Column
Infiniti	QX56	Std. Key Automatic (w/ alarm)	2005 - 2009	OEM Arm/Lock	WHITE	40	8	INSERT PIN *	(-)	BCM Right Side Of Column
				OEM Disarm/Unlock	WHITE	40	7	INSERT PIN *	(-)	BCM Right Side Of Column
				Parking Lights	White	24	12	RED/BLUE	(+)	Drivers Kick Panel
				Horn Honk	GRAY	8	2	RED/WHITE	(-)	Horn Switch Top of Steering Column
Nissan	350Z	Std. Key Automatic (w/ alarm)	2006 - 2009	OEM Arm/Lock	WHITE	40	8	INSERT PIN *	(-)	BCM Drivers Kick Panel
				OEM Disarm/Unlock	WHITE	40	7	INSERT PIN *	(-)	BCM Drivers Kick Panel
				Parking Lights	-	-	-	RED/BLUE	(+)	Drivers Kick Panel
				Horn Honk	GRAY	8	2	GREEN/BLACK	(-)	Horn Switch Top of Steering Column
Nissan	Altima	Std. Key Automatic (w/ alarm)	2005 - 2006	OEM Arm/Lock	WHITE	40	8	INSERT PIN *	(-)	BCM Right Side Of Fuse Box
				OEM Disarm/Unlock	WHITE	40	7	INSERT PIN *	(-)	BCM Right Side Of Fuse Box
				Parking Lights	-	-	-	RED/BLUE	(+)	Drivers Kick Panel
				Horn Honk	-	-	-	GREEN/WHITE	(-)	Horn Switch Top of Steering Column
Nissan	Armada	Std. Key Automatic (w/ alarm)	2005 - 2015	OEM Arm/Lock	WHITE	40	8	INSERT PIN *	(-)	BCM Right Side Of Column
				OEM Disarm/Unlock	WHITE	40	7	INSERT PIN *	(-)	BCM Right Side Of Column
				Parking Lights	White	24	12	RED/BLUE	(+)	Drivers Kick Panel
				Horn Honk	GRAY	8	2	RED/WHITE	(-)	Horn Switch Top of Steering Column
Nissan	Cube	Std. Key Automatic (w/ alarm)	2009 - 2014	OEM Arm/Lock	WHITE	40	8	WHITE/BLACK	(-)	BCM Right Side Of Fuse Box
				OEM Disarm/Unlock	WHITE	40	7	WHITE/RED	(-)	BCM Right Side Of Fuse Box
				Parking Lights	WHITE	16	13	BROWN/WHITE	(+)	Drivers Kick Panel
				Horn Honk	-	-	-	RED/BLACK	(-)	Horn Switch Top of Steering Column
Nissan	Frontier	Std. Key Automatic (w/ alarm))	2005 - 2019	OEM Arm/Lock	-	-	-	LT. BLUE	(-)	Drivers Kick Panel Harness From Door
				OEM Disarm/Unlock	-	-	-	GRAY	(-)	Drivers Kick Panel Harness From Door
				Parking Lights	WHITE	6	4	RED	(+)	Electric Brake Plug Behind ODBII Plug
				Horn Honk	-	-	-	BROWN or RED	(-)	Horn Switch Top of Steering Column
Nissan	Juke	Std. Key Automatic (w/ alarm)	2011 - 2017	OEM Arm/Lock	-	-	-	RED	(-)	Drivers Kick Panel Harness From Door
				OEM Disarm/Unlock	-	-	-	BLUE	(-)	Drivers Kick Panel Harness From Door
				Parking Lights	WHITE	100	70	VIOLET	(+)	Drivers Kick Panel
				Horn Honk	GRAY	8	8	RED or LT. GREEN	(-)	Horn Switch Top of Steering Column
Nissan	Maxima	Std. Key Automatic (w/ alarm)	2007 - 2008	OEM Arm/Lock	WHITE	40	8	INSERT PIN *	(-)	BCM Right Side Of Fuse Box
				OEM Disarm/Unlock	WHITE	40	7	INSERT PIN *	(-)	BCM Right Side Of Fuse Box
				Parking Lights	-	-	-	RED/BLUE	(+)	Drivers Kick Panel
				Horn Honk	GRAY	8	2	RED	(-)	Horn Switch Top of Steering Column

\* See diagram on page 4 for Insert Pin instructions.

## Wire Location Chart Diagram #2

Make	Model	Trim	Year	Item	Connector Color	Connector Pins	Pin #	Wire Color	Polarity	Location
Nissan	Maxima	Std. Key Automatic (w/ alarm)	2004 - 2006	OEM Arm/Lock	WHITE	40	8	INSERT PIN *	(-)	BCM Right Side Of Fuse Box
				OEM Disarm/Unlock	WHITE	40	7	INSERT PIN *	(-)	BCM Right Side Of Fuse Box
				Parking Lights	-	-	-	RED/BLUE	(+)	Drivers Kick Panel
				Horn Honk	GRAY	8	2	GREEN/WHITE	(-)	Horn Switch Top of Steering Column
Nissan	Micra	Std. Key Automatic	2015 - 2019	OEM Arm/Lock	WHITE	40	8	GRAY	(-)	BCM Drivers Kick Panel
				OEM Disarm/Unlock	WHITE	40	7	WHITE	(-)	BCM Drivers Kick Panel
				Parking Lights	GRAY	16	4	RED	(+)	Drivers Kick Panel
				Horn Honk	GRAY	8	5	RED	(-)	Horn Switch Top of Steering Column
Nissan	NV 200	Std. Key Automatic	2013 - 2021	OEM Arm/Lock	WHITE	12	4	PINK	(-)	Drivers Kick Harness From Door
				OEM Disarm/Unlock	WHITE	12	7	BLACK	(-)	Drivers Kick Harness From Door
				Parking Lights	-	-	-	VIOLET	(+)	Drivers Firewall Harness
				Horn Honk	GRAY	8	5	RED	(-)	Horn Switch Top of Steering Column
Nissan	NV 1500	Std. Key Automatic	2012 - 2021	OEM Arm/Lock	-	-	-	LT. BLUE	(-)	Drivers Kick Harness From Door
				OEM Disarm/Unlock	-	-	-	YELLOW	(-)	Drivers Kick Harness From Door
				Parking Lights	WHITE	4	3	RED	(+)	Drivers Kick Panel
				Horn Honk	WHITE	16	14	WHITE	(-)	Drivers Kick Panel
Nissan	NV 2500	Std. Key Automatic	2012 - 2021	OEM Arm/Lock	-	-	-	LT. BLUE	(-)	Drivers Kick Harness From Door
				OEM Disarm/Unlock	-	-	-	YELLOW	(-)	Drivers Kick Harness From Door
				Parking Lights	WHITE	4	3	RED	(+)	Drivers Kick Panel
				Horn Honk	WHITE	16	14	WHITE	(-)	Drivers Kick Panel
Nissan	NV 3500	Std. Key Automatic	2012 - 2021	OEM Arm/Lock	-	-	-	LT. BLUE	(-)	Drivers Kick Harness From Door
				OEM Disarm/Unlock	-	-	-	YELLOW	(-)	Drivers Kick Harness From Door
				Parking Lights	WHITE	4	3	RED	(+)	Drivers Kick Panel
				Horn Honk	WHITE	16	14	WHITE	(-)	Drivers Kick Panel
Nissan	Pathfinder	Std. Key Automatic (w/ alarm)	2005 - 2012	OEM Arm/Lock	WHITE	40	8	INSERT PIN *	(-)	BCM Right Side Of Column
				OEM Disarm/Unlock	WHITE	40	7	INSERT PIN *	(-)	BCM Right Side Of Column
				Parking Lights	GRAY	8	1	GRAY	(+)	Drivers Kick Panel
				Horn Honk	WHITE	16	9	BROWN	(-)	Drivers Kick Panel
Nissan	Quest	Std. Key Automatic (w/ alarm))	2004 - 2009	OEM Arm/Lock	WHITE	40	8	INSERT PIN *	(-)	BCM Left Os Steering Column
				OEM Disarm/Unlock	WHITE	40	7	INSERT PIN *	(-)	BCM Left Os Steering Column
				Parking Lights	-	-	-	RED/BLUE	(+)	Drivers Kick Panel
				Horn Honk	-	-	-	GREEN/WHITE	(-)	Horn Switch Top of Steering Column
Nissan	Rogue	Std. Key Automatic (w/ alarm)	2008 - 2013	OEM Arm/Lock	-	-	-	RED	(-)	Drivers Kick Harness From Door
				OEM Disarm/Unlock	-	-	-	BLUE	(-)	Drivers Kick Harness From Door
				Parking Lights	-	-	-	RED	(+)	Drivers Kick Panel
				Horn Honk	-	-	-	GRAY	(-)	Horn Switch Top of Steering Column

\* See diagram on page 4 for Insert Pin instructions.

## Wire Location Chart Diagram #2

Make	Model	Trim	Year	Item	Connector Color	Connector Pins	Pin #	Wire Color	Polarity	Location
Nissan	Sentra	Std. Key Automatic	2007 - 2012	OEM Arm/Lock	-	-	-	BROWN	(-)	Drivers Kick Harness From Door
				OEM Disarm/Unlock	-	-	-	WHITE	(-)	Drivers Kick Harness From Door
				Parking Lights	GRAY	16	4	RED	(+)	Right Side Of Fuse Box
				Horn Honk	GRAY	8	3	GREEN	(-)	Horn Switch Top of Steering Column
Nissan	Sentra	Std. Key Automatic	2013 - 2019	OEM Arm/Lock	-	-	-	VIOLET	(-)	Drivers Kick Harness From Door
				OEM Disarm/Unlock	-	-	-	BLUE	(-)	Drivers Kick Harness From Door
				Parking Lights	GRAY	16	4	RED	(+)	Right Side Of Fuse Box
				Horn Honk	GRAY	8	3	GREEN	(-)	Horn Switch Top of Steering Column
Nissan	Titan	Std. Key Automatic (w/ alarm)	2005 - 2015	OEM Arm/Lock	WHITE	40	8	INSERT PIN *	(-)	BCM Right Side Of Column
				OEM Disarm/Unlock	WHITE	40	7	INSERT PIN *	(-)	BCM Right Side Of Column
				Parking Lights	WHITE	6	4	RED/BLUE	(+)	Electric Brake Plug Left Of Column
				Horn Honk	GRAY	8	2	RED/WHITE	(-)	Horn Switch Top of Steering Column
Nissan	Versa	Std. Key Automatic (w/ alarm)	2007 - 2019	OEM Arm/Lock	-	-	-	GRAY	(-)	Drivers Kick Harness From Door
				OEM Disarm/Unlock	-	-	-	WHITE	(-)	Drivers Kick Harness From Door
				Parking Lights	GRAY	16	4	RED	(+)	Drivers Kick Panel
				Horn Honk	GRAY	8	5	RED	(-)	Horn Switch Top of Steering Column
Nissan	Versa Note	Std. Key Automatic	2014 - 2018	OEM Arm/Lock	-	-	-	GRAY	(-)	Drivers Kick Harness From Door
				OEM Disarm/Unlock	-	-	-	WHITE	(-)	Drivers Kick Harness From Door
				Parking Lights	WHITE	24	3	RED	(+)	Drivers Kick Panel
				Horn Honk	YELLOW	8	5	RED	(-)	Horn Switch Top of Steering Column
Nissan	Xterra	Std. Key Automatic (w/ alarm)	2005 - 2015	OEM Arm/Lock	-	-	-	LT. BLUE	(-)	Drivers Kick Panel
				OEM Disarm/Unlock	-	-	-	GRAY	(-)	Drivers Kick Panel
				Parking Lights	GRAY	8	1	GRAY	(+)	Drivers Kick Panel
				Horn Honk	WHITE	16	9	BROWN	(-)	Drivers Kick Panel
Suzuki	Equator	Std. Key Automatic (w/ alarm)	2009 - 2011	OEM Arm/Lock	-	-	-	LT. BLUE	(-)	Drivers Kick Panel
				OEM Disarm/Unlock	-	-	-	GRAY	(-)	Drivers Kick Panel
				Parking Lights	GRAY	8	1	GRAY	(+)	Drivers Kick Panel
				Horn Honk	WHITE	16	9	BROWN	(-)	Drivers Kick Panel

\* See diagram on page 4 for Insert Pin instructions.

## MODEL: OL-HRN-RS-NI4

### AL-XX70-B Diagram #2

**INSTALLER Feature #8 MUST be programmed to Double Unlock (Option #3).**  
See AL-XX70-B Installation Guide for programming procedure.

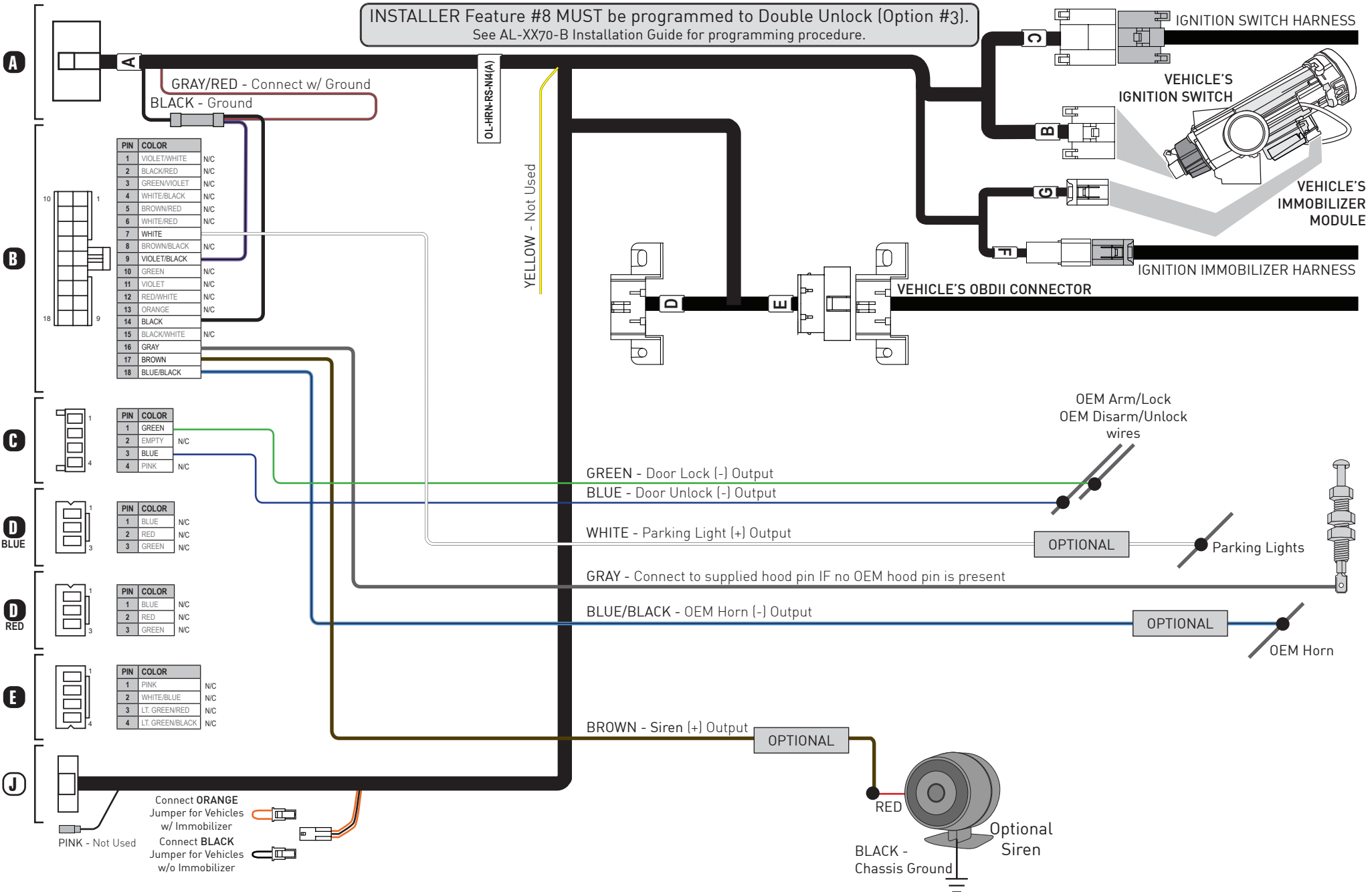

## Wire Location Chart Diagram #3

Make	Model	Trim	Year	Item	Connector Color	Connector Pins	Pin #	Wire Color	Polarity	Location
Infiniti	QX56	W/ Intelli-Key Automatic	2008 - 2010	Intelli-Key Ignition	WHITE	40	6	GREEN/RED	(+)	Intelli-Key Module Behind Gauge Cluster
				Keysense	GRAY	6	4	BLACK/RED	(+)	Ignition Switch
				Parking Lights	White	24	12	RED/BLUE	(+)	Drivers Kick Panel
				Horn Honk	GRAY	8	2	RED/WHITE	(-)	Horn Switch Top of Steering Column
Nissan	Armada	W/ Intelli-Key Automatic	2008 - 2015	Intelli-Key Ignition	WHITE	40	6	GREEN/RED	(+)	Intelli-Key Module Behind Gauge Cluster
				Keysense	GRAY	6	4	BLACK/RED	(+)	Ignition Switch
				Parking Lights	White	24	12	RED/BLUE	(+)	Drivers Kick Panel
				Horn Honk	GRAY	8	2	RED/WHITE	(-)	Horn Switch Top of Steering Column
Nissan	Maxima	W/ Intelli-Key Automatic	2007 - 2008	Intelli-Key Ignition	WHITE	40	6	GREEN	(+)	Intelli-Key Module Right Of Steering Column
				Keysense	GRAY	6	4	RED/BLACK	(+)	Ignition Switch
				Parking Lights	-	-	-	RED/BLUE	(+)	Drivers Kick Panel
				Horn Honk	GRAY	8	2	RED	(-)	Horn Switch Top of Steering Column
Nissan	Pathfinder	W/ Intelli-Key Automatic	2008 - 2012	Intelli-Key Ignition	WHITE	40	6	WHITE/GREEN	(+)	Intelli-Key Module Behind Glove Box
				Keysense	GRAY	6	4	LT. BLUE	(+)	Ignition Switch
				Parking Lights	GRAY	8	1	GRAY	(+)	Drivers Kick Panel
				Horn Honk	WHITE	16	9	BROWN	(-)	Drivers Kick Panel
Nissan	Rogue	W/ Intelli-Key Automatic	2008 - 2013	Intelli-Key Ignition	WHITE	40	6	WHITE	(+)	Intelli-Key Module Behind Power Mirror Switch
				Keysense	GRAY	6	1	LT. GREEN	(+)	Ignition Switch
				Parking Lights	-	-	-	RED	(+)	Drivers Kick Panel
				Horn Honk	-	-	-	GRAY	(-)	Horn Switch Top of Steering Column
Nissan	Rogue Select	W/ Intelli-Key Automatic	2014 - 2015	Intelli-Key Ignition	WHITE	40	6	WHITE	(+)	Intelli-Key Module Behind Power Mirror Switch
				Keysense	GRAY	6	1	LT. GREEN	(+)	Ignition Switch
				Parking Lights	-	-	-	RED	(+)	Drivers Kick Panel
				Horn Honk	-	-	-	GRAY	(-)	Horn Switch Top of Steering Column
Nissan	Sentra	W/ Intelli-Key Automatic	2007 - 2012	Intelli-Key Ignition	WHITE	40	6	BROWN	(+)	Intelli-Key Module Behind Glove Box
				Keysense	GRAY	6	1	VIOLET	(+)	Ignition Switch
				Parking Lights	GRAY	16	4	RED	(+)	Right Side Of Fuse Box
				Horn Honk	GRAY	8	3	GREEN	(-)	Horn Switch Top of Steering Column
Nissan	Versa	W/ Intelli-Key Automatic	2007 - 2011	Intelli-Key Ignition	WHITE	40	6	YELLOW	(+)	Intelli-Key Module Behind Glove Box
				Keysense	GRAY	6	1	LT. GREEN	(+)	Ignition Switch
				Parking Lights	GRAY	16	4	RED	(+)	Drivers Kick Panel
				Horn Honk	GRAY	8	5	RED	(-)	Horn Switch Top of Steering Column

## MODEL: OL-HRN-RS-NI4

### AL-XX70-B Diagram #3

**INSTALLER Feature #5 MUST be programmed to GWR/Status (Option #5).**  
See AL-XX70-B Installation Guide for programming procedure.

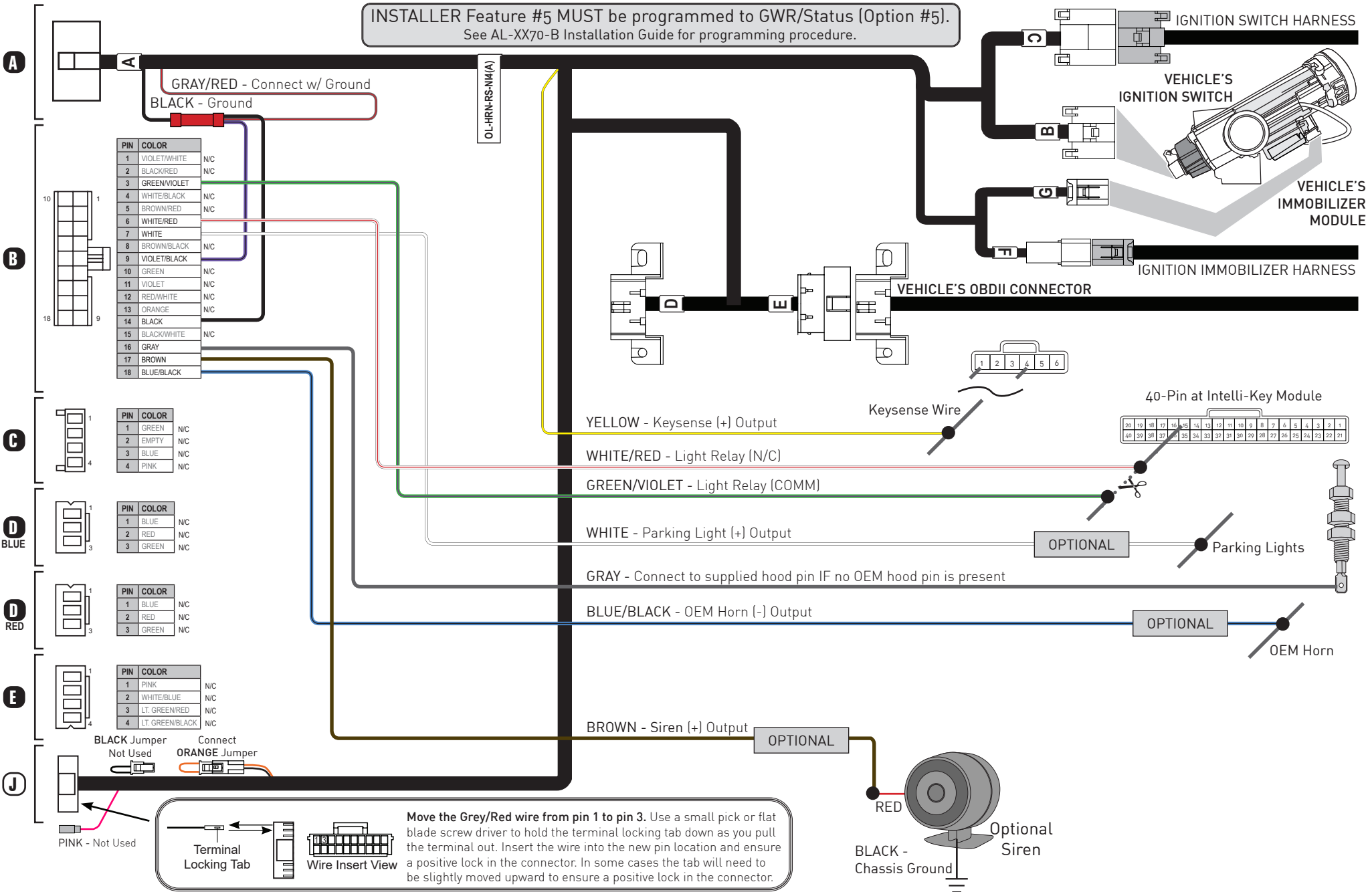

## Wire Location Chart Diagram #4

Make	Model	Trim	Year	Item	Connector Color	Connector Pins	Pin #	Wire Color	Polarity	Location
Nissan	Altima	Std. Key Manual (w/o alarm)	2005 - 2006	Parking Lights	-	-	-	RED/BLUE	(+)	Drivers Kick Panel
				Horn Honk	-	-	-	GREEN/WHITE	(-)	Horn Switch Top of Steering Column
				Clutch Bypass	BLUE	2	1	GREEN/RED	(-)	Clutch Switch
				Parking Brake	-	1	1	GREEN	(-)	Parking Brake Switch
Nissan	Cube	Std. Key Manual (w/o alarm)	2009 - 2014	Parking Lights	WHITE	16	13	BROWN/WHITE	(+)	Drivers Kick Panel
				Horn Honk	-	-	-	RED/BLACK	(-)	Horn Switch Top of Steering Column
				Clutch Bypass	WHITE	4	4	BROWN	(+)	Clutch Switch
				Parking Brake	BLACK	1	1	LT. BLUE	(-)	Parking Brake Switch
Nissan	Frontier	Std. Key Manual (w/o alarm)	2005 - 2019	Parking Lights	WHITE	6	4	RED	(+)	Electric Brake Plug Behind Obd-ii Plug
				Horn Honk	-	-	-	BROWN or RED	(-)	Horn Switch Top of Steering Column
				Clutch Bypass	BLUE	2	2	RED or BLUE	(+)	Clutch Switch
				Parking Brake	-	-	-	GREEN	(-)	Parking Brake Switch
Nissan	Juke	Std. Key Manual (w/o alarm)	2011 - 2017	Parking Lights	WHITE	100	70	VIOLET	(+)	Drivers Kick Panel
				Horn Honk	GRAY	8	8	RED or LT. GREEN	(-)	Horn Switch Top of Steering Column
				Clutch Bypass	WHITE	4	4	BROWN	(+)	Clutch Switch
				Parking Brake	BLACK	1	1	LT. BLUE	(-)	Parking Brake Switch
Nissan	Maxima	Std. Key Manual (w/o alarm)	2004 - 2006	Parking Lights	-	-	-	RED/BLUE	(+)	Drivers Kick Panel
				Horn Honk	GRAY	8	2	GREEN/WHITE	(-)	Horn Switch Top of Steering Column
				Clutch Bypass	BLUE	2	1	GREEN/RED	(-)	Clutch Switch
				Parking Brake	BLACK	1	1	PINK/BLACK	(-)	Parking Brake Switch
Nissan	Sentra	Std. Key Manual (w/o alarm)	2007 - 2012	Parking Lights	GRAY	16	4	RED	(+)	Right Side Of Fuse Box
				Horn Honk	GRAY	8	3	GREEN	(-)	Horn Switch Top of Steering Column
				Clutch Bypass	BROWN	2	1	BROWN/RED	(+)	Clutch Switch
				Parking Brake	-	-	-	GREEN	(-)	Parking Brake Switch or Passenger Kick
Nissan	Versa	Std. Key Manual (w/o alarm)	2007 - 2019	Parking Lights	GRAY	16	4	RED	(+)	Drivers Kick Panel
				Horn Honk	GRAY	8	5	RED	(-)	Horn Switch Top of Steering Column
				Clutch Bypass	BROWN	2	2	LT. GREEN	(+)	Clutch Switch
				Parking Brake	BLACK	1	1	LT. BLUE	(-)	Parking Brake Switch
Nissan	Xterra	Std. Key Manual (w/o alarm)	2005 - 2015	Parking Lights	GRAY	8	1	GRAY	(+)	Drivers Kick Panel
				Horn Honk	WHITE	16	9	BROWN	(-)	Drivers Kick Panel
				Clutch Bypass	BLUE	2	2	RED or BLUE	(+)	Clutch Switch
				Parking Brake	-	-	-	GREEN	(-)	Parking Brake Switch
Suzuki	Equator	Std. Key Manual (w/o alarm)	2009 - 2011	Parking Lights	GRAY	8	1	GRAY	(+)	Drivers Kick Panel
				Horn Honk	WHITE	16	9	BROWN	(-)	Drivers Kick Panel
				Clutch Bypass	BLUE	2	2	RED or BLUE	(+)	Clutch Switch
				Parking Brake	-	-	-	GREEN	(-)	Parking Brake Switch

## MODEL: OL-HRN-RS-NI4 AL-XX70-B Diagram #4

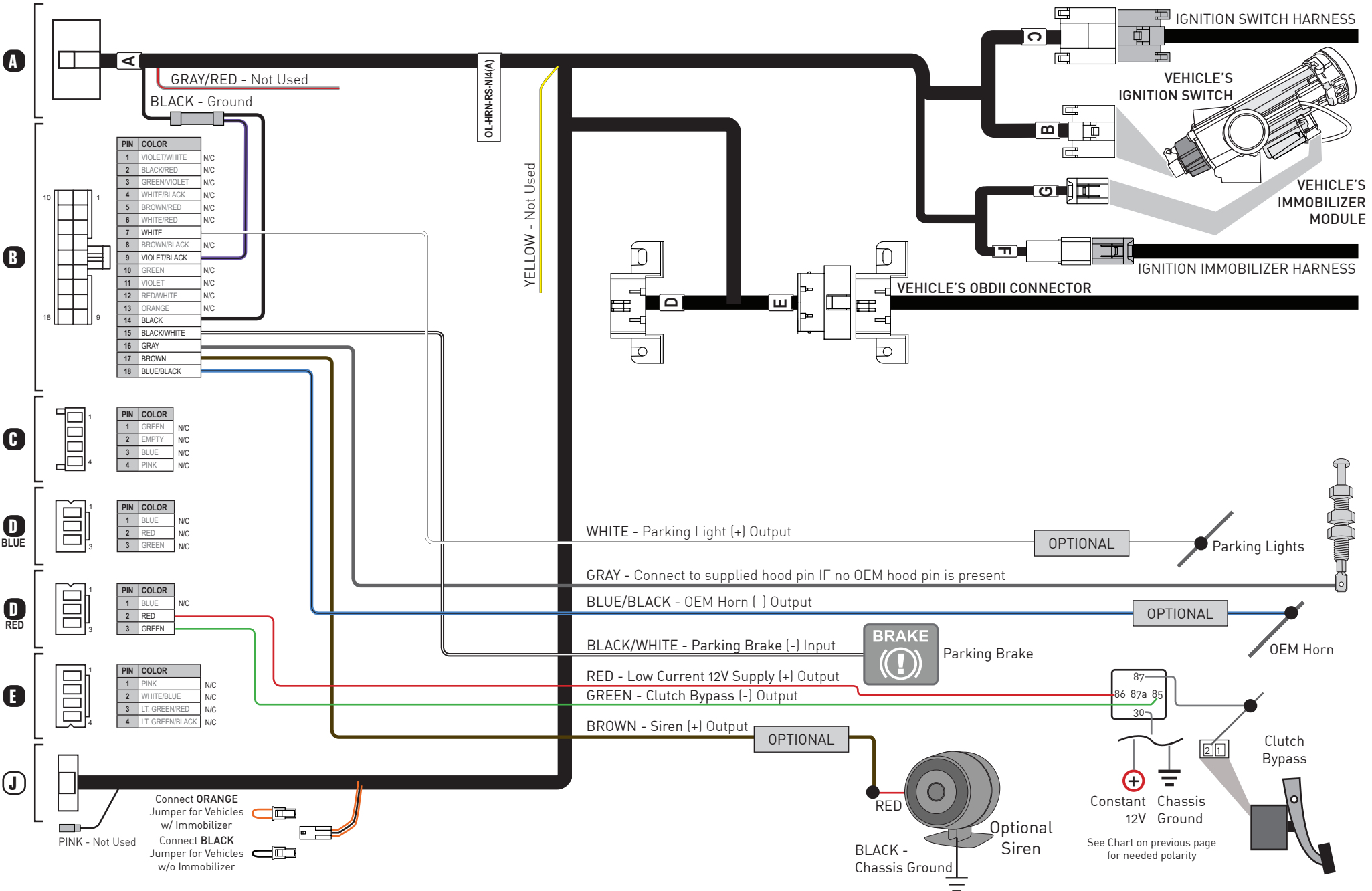

## Wire Location Chart Diagram #5

Make	Model	Trim	Year	Item	Connector Color	Connector Pins	Pin #	Wire Color	Polarity	Location
Nissan	Altima	Std. Key Manual (w/ alarm)	2005 - 2006	OEM Arm/Lock	WHITE	40	8	INSERT PIN *	(-)	BCM Right Side Of Fuse Box
				OEM Disarm/Unlcok	WHITE	40	7	INSERT PIN *	(-)	BCM Right Side Of Fuse Box
				Parking Lights	-	-	-	RED/BLUE	(+)	Drivers Kick Panel
				Horn Honk	-	-	-	GREEN/WHITE	(-)	Horn Switch Top of Steering Column
				Clutch Bypass	BLUE	2	1	GREEN/RED	(-)	Clutch Switch
				Parking Brake	-	1	1	GREEN	(-)	Parking Brake Switch
Nissan	Frontier	Std. Key Manual (w/ alarm)	2005 - 2019	OEM Arm/Lock	-	-	-	LT. BLUE	(-)	Drivers Kick Panel Harness From Door
				OEM Disarm/Unlcok	-	-	-	GRAY	(-)	Drivers Kick Panel Harness From Door
				Parking Lights	WHITE	6	4	RED	(+)	Electric Brake Plug Behind Obd-ii Plug
				Horn Honk	-	-	-	BROWN or RED	(-)	Horn Switch Top of Steering Column
				Clutch Bypass	BLUE	2	2	RED or BLUE	(+)	Clutch Switch
				Parking Brake	-	-	-	GREEN	(-)	Parking Brake Switch
Nissan	Juke	Std. Key Manual (w/ alarm)	2011 - 2017	OEM Arm/Lock	-	-	-	RED	(-)	Drivers Kick Panel Harness From Door
				OEM Disarm/Unlcok	-	-	-	BLUE	(-)	Drivers Kick Panel Harness From Door
				Parking Lights	WHITE	100	70	VIOLET	(+)	Drivers Kick Panel
				Horn Honk	GRAY	8	8	RED or LT. GREEN	(-)	Horn Switch Top of Steering Column
				Clutch Bypass	WHITE	4	4	BROWN	(+)	Clutch Switch
				Parking Brake	BLACK	1	1	LT. BLUE	(-)	Parking Brake Switch
Nissan	Maxima	Std. Key Manual (w/ alarm)	2004 - 2006	OEM Arm/Lock	WHITE	40	8	INSERT PIN *	(-)	BCM Right Side Of Fuse Box
				OEM Disarm/Unlcok	WHITE	40	7	INSERT PIN *	(-)	BCM Right Side Of Fuse Box
				Parking Lights	-	-	-	RED/BLUE	(+)	Drivers Kick Panel
				Horn Honk	GRAY	8	2	GREEN/WHITE	(-)	Horn Switch Top of Steering Column
				Clutch Bypass	BLUE	2	1	GREEN/RED	(-)	Clutch Switch
				Parking Brake	BLACK-	1	1	PINK/BLACK	(-)	Parking Brake Switch
Nissan	Micra	Std. Key Manual	2015 - 2019	OEM Arm/Lock	WHITE	40	8	GRAY	(-)	BCM Drivers Kick Panel
				OEM Disarm/Unlcok	WHITE	40	7	WHITE	(-)	BCM Drivers Kick Panel
				Parking Lights	GRAY	16	4	RED	(+)	Drivers Kick Panel
				Horn Honk	GRAY	8	5	RED	(-)	Horn Switch Top of Steering Column
				Clutch Bypass	BROWN	2	2	LT. GREEN	(+)	Clutch Switch
				Parking Brake	BLACK	1	1	LT. BLUE	(-)	Parking Brake Switch
Nissan	Sentra	Std. Key Manual (w/ alarm)	2007 - 2012	OEM Arm/Lock	-	-	-	BROWN	(-)	Drivers Kick Harness From Door
				OEM Disarm/Unlock	-	-	-	WHITE	(-)	Drivers Kick Harness From Door
				Parking Lights	GRAY	16	4	RED	(+)	Right Side Of Fuse Box
				Horn Honk	GRAY	8	3	GREEN	(-)	Horn Switch Top of Steering Column
				Clutch Bypass	BROWN	2	1	BROWN/RED	(+)	Clutch Switch
				Parking Brake	-	-	-	GREEN	(-)	Passenger Kick Panel Harness Going to Rear of Vehicle

\* See diagram on page 4 for Insert Pin instructions.

## Wire Location Chart Diagram #5

Make	Model	Trim	Year	Item	Connector Color	Connector Pins	Pin #	Wire Color	Polarity	Location
Nissan	Sentra	Std. Key Manual	2013 - 2019	OEM Arm/Lock	-	-	-	VIOLET	(-)	Drivers Kick Harness From Door
				OEM Disarm/Unlcok	-	-	-	BLUE	(-)	Drivers Kick Harness From Door
				Parking Lights	GRAY	16	4	RED	(+)	Right Side Of Fuse Box
				Horn Honk	GRAY	8	3	GREEN	(-)	Horn Switch Top of Steering Column
				Clutch Bypass	BROWN	2	1	BROWN/RED	(+)	Clutch Switch
				Parking Brake	-	-	-	GREEN	(-)	Parking Brake Switch Or Passenger Kick
Nissan	Versa	Std. Key Manual (w/ alarm)	2013 - 2019	OEM Arm/Lock	-	-	-	GRAY	(-)	Drivers Kick Harness From Door
				OEM Disarm/Unlcok	-	-	-	WHITE	(-)	Drivers Kick Harness From Door
				Parking Lights	GRAY	16	4	RED	(+)	Drivers Kick Panel
				Horn Honk	GRAY	8	5	RED	(-)	Horn Switch Top of Steering Column
				Clutch Bypass	BROWN	2	2	LT. GREEN	(+)	Clutch Switch
				Parking Brake	BLACK	1	1	LT. BLUE	(-)	Parking Brake Switch
Nissan	Versa Note	Std. Key Manual	2014 - 2018	OEM Arm/Lock	-	-	-	GRAY	(-)	Drivers Kick Harness From Door
				OEM Disarm/Unlcok	-	-	-	WHITE	(-)	Drivers Kick Harness From Door
				Parking Lights	WHITE	24	3	RED	(+)	Drivers Kick Panel
				Horn Honk	YELLOW	8	5	RED	(-)	Horn Switch Top of Steering Column
				Clutch Bypass	BROWN	2	2	LT. GREEN	(+)	Clutch Switch
				Parking Brake	BLACK	1	1	LT. BLUE	(-)	Parking Brake Switch
Nissan	Xterra	Std. Key Manual (w/ alarm)	2005 - 2015	OEM Arm/Lock	-	-	-	LT. BLUE	(-)	Drivers Kick Panel
				OEM Disarm/Unlcok	-	-	-	GRAY	(-)	Drivers Kick Panel
				Parking Lights	GRAY	8	1	GRAY	(+)	Drivers Kick Panel
				Horn Honk	WHITE	16	9	BROWN	(-)	Drivers Kick Panel
				Clutch Bypass	BLUE	2	2	RED or BLUE	(+)	Clutch Switch
				Parking Brake	-	-	-	GREEN	(-)	Parking Brake Switch
Suzuki	Equator	Std. Key Manual (w/ alarm)	2009 - 2011	OEM Arm/Lock	-	-	-	LT. BLUE	(-)	Drivers Kick Panel
				OEM Disarm/Unlcok	-	-	-	GRAY	(-)	Drivers Kick Panel
				Parking Lights	GRAY	8	1	GRAY	(+)	Drivers Kick Panel
				Horn Honk	WHITE	16	9	BROWN	(-)	Drivers Kick Panel
				Clutch Bypass	BLUE	2	2	RED or BLUE	(+)	Clutch Switch
				Parking Brake	-	-	-	GREEN	(-)	Parking Brake Switch

\* See diagram on page 4 for Insert Pin instructions.

## MODEL: OL-HRN-RS-NI4

### AL-XX70-B Diagram #5

**INSTALLER Feature #8 MUST be programmed to Double Unlock (Option #3).**  
See AL-XX70-B Installation Guide for programming procedure.

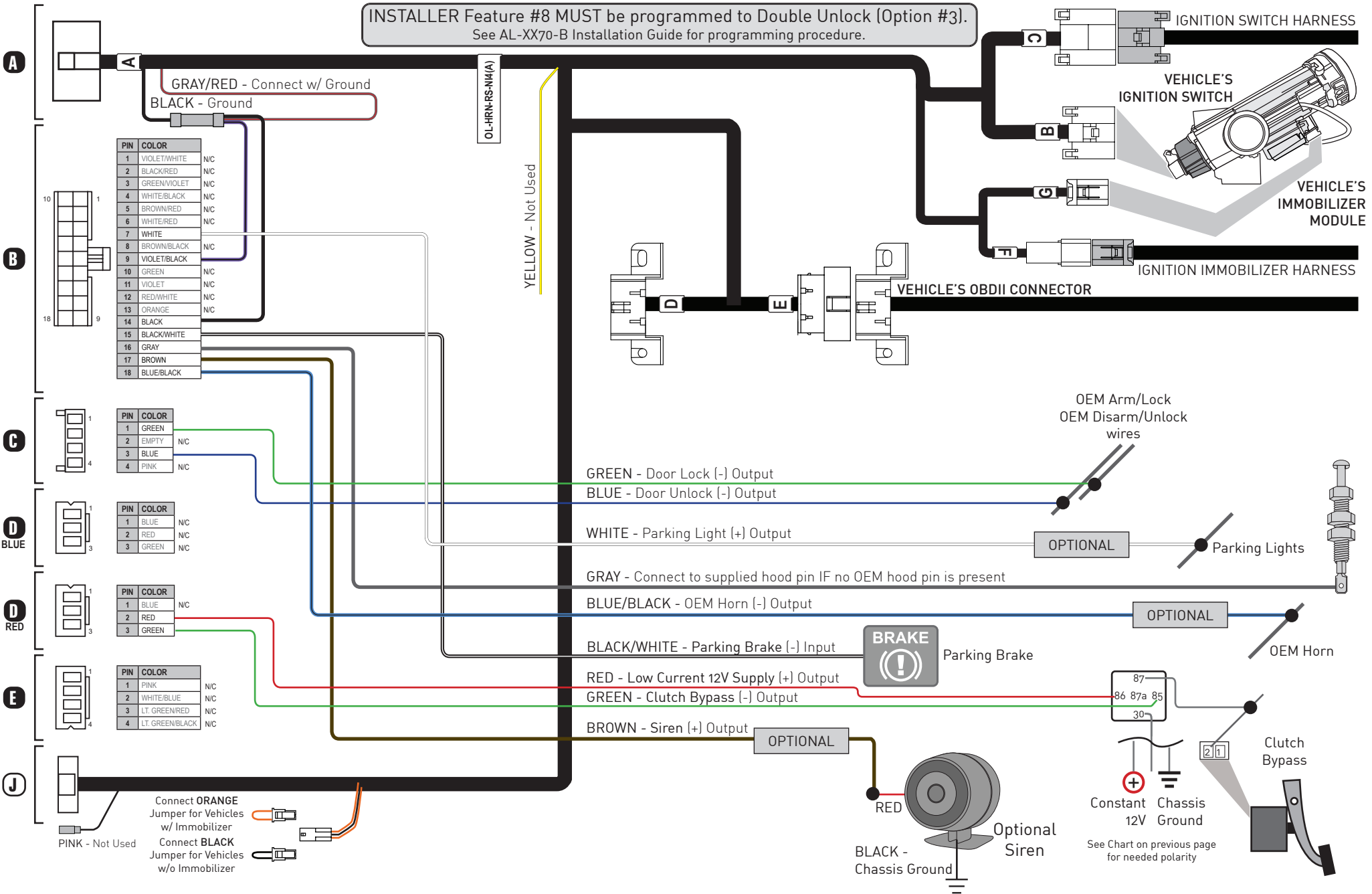

**Wire Location Chart Diagram #6**

Make	Model	Trim	Year	Item	Connector Color	Connector Pins	Pin #	Wire Color	Polarity	Location
Nissan	Versa	W/ Intelli-Key Manual	2007 - 2011	Intelli-Key Ignition	WHITE	40	6	YELLOW	(+)	Intelli-Key Module Behind Glove Box
				Keysense	GRAY	6	1	LT. GREEN	(+)	Ignition Switch
				Parking Lights	GRAY	16	4	RED	(+)	Drivers Kick Panel
				Horn Honk	GRAY	8	5	RED	(-)	Horn Switch Top of Steering Column
				Clutch Bypass	BROWN	2	2	LT. GREEN	(+)	Clutch Switch
				Parking Brake	BLACK	1	1	LT. BLUE	(-)	Parking Brake Switch

## MODEL: OL-HRN-RS-NI4

### AL-XX70-B Diagram #6

**INSTALLER Feature #5 MUST be programmed to GWR/Status (Option #5).**  
See AL-XX70-B Installation Guide for programming procedure.

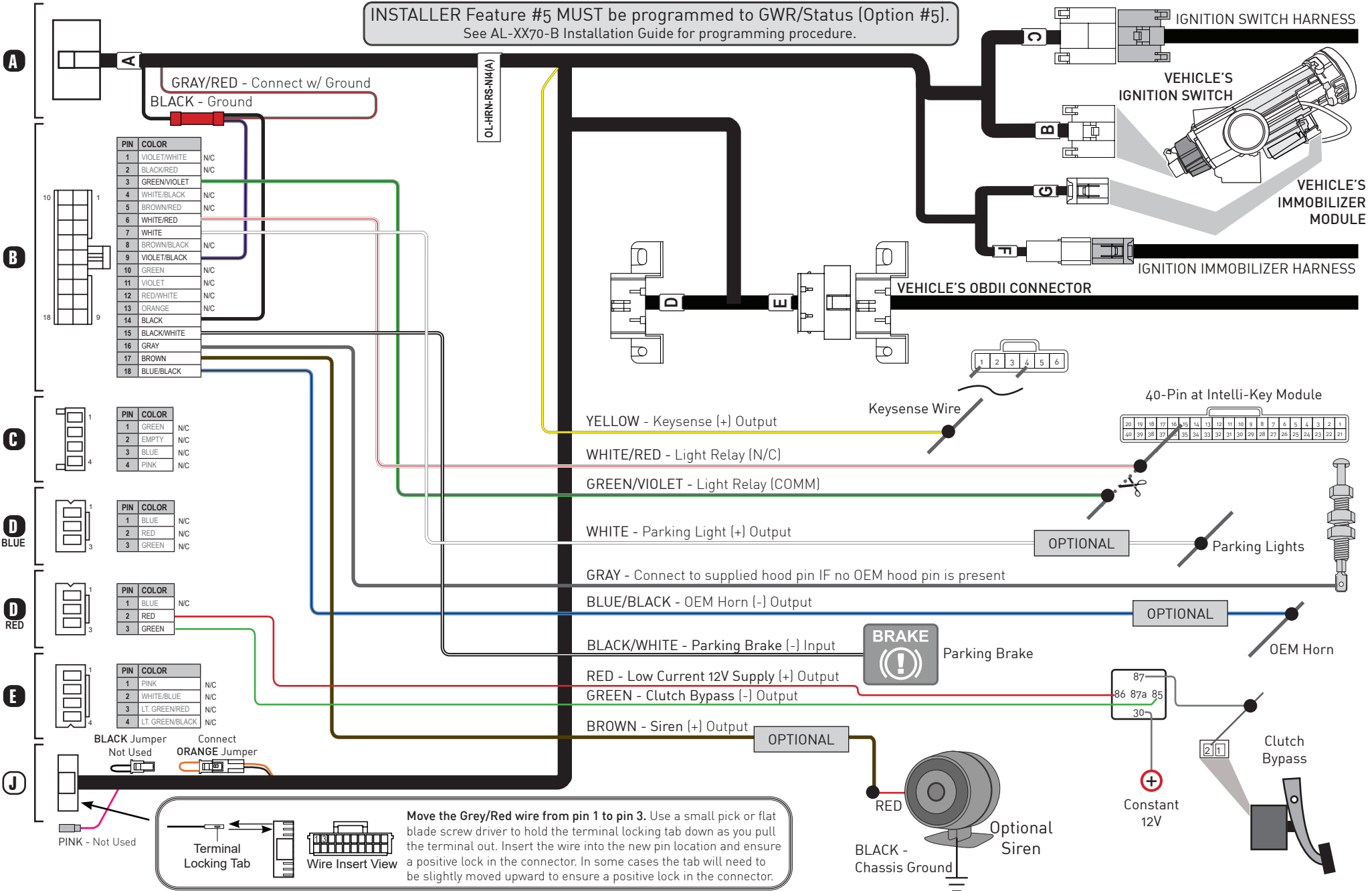

**AL-XX70-B Optional Accessories**

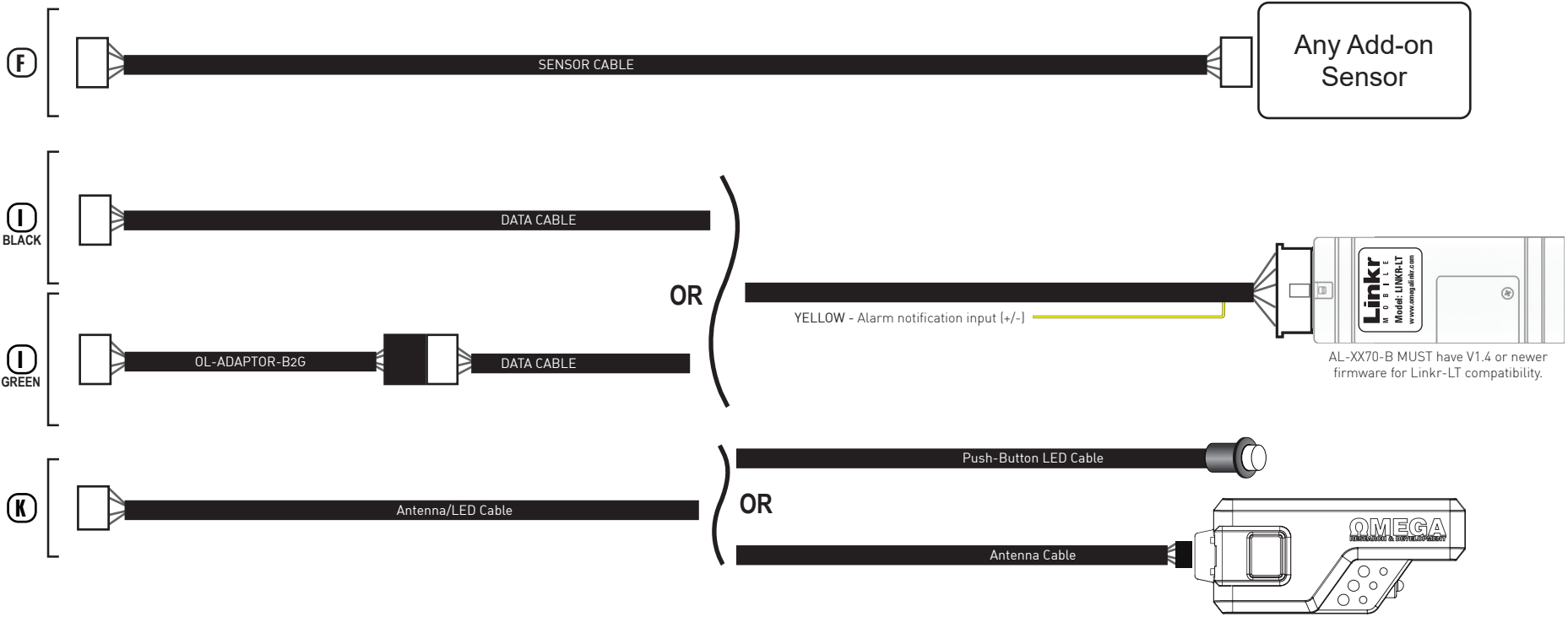

## Blade Installation

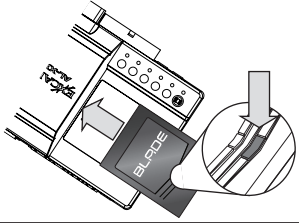

Slide Blade into unit.  
Notice programming button under LED.

Ready for Blade Programming Procedure.

## Blade Programming

### NOTES:

1. To complete this process you will need one regular key or one valet key.

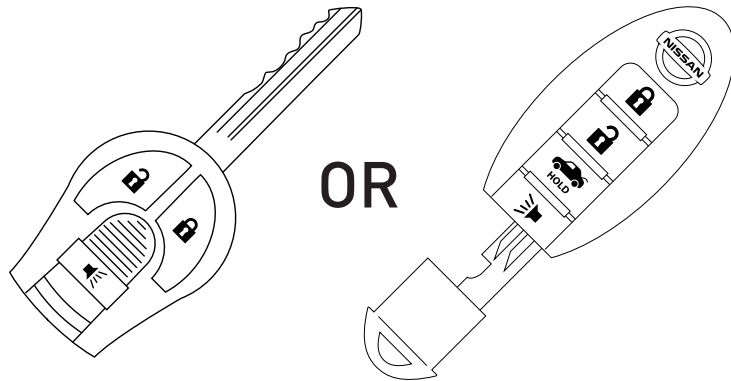

2. When progeamming, all key fobs must be located at least 10 feet away from the vehilce.

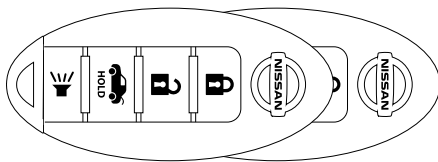

1

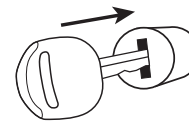

Insert the key into ignition.

2

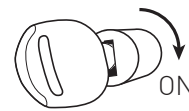

Turn the key to ON position.

3

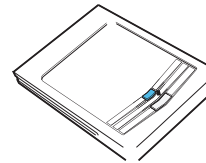

Wait, the LED will turn solid BLUE for 2 seconds.

4



Turn key to OFF position.

5

Proceed to AL-XX70-B Programming/  
Vehicle Learn.

## AL-XX70-B Programming/Vehicle Learn V1.6 (see installation guide for older versions)

### Before You Begin:

- Make sure all wires/harnesses are connected.
- Program the BLADE to the vehicle per the instructions on the previous pages.
- Connect any additional accessories/modules to the data ports.
- **MANUAL TRANSMISSION VEHICLES ONLY:** Set the parking brake. The BLACK/WHITE wire must be connected to the parking brake wire.

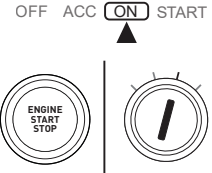
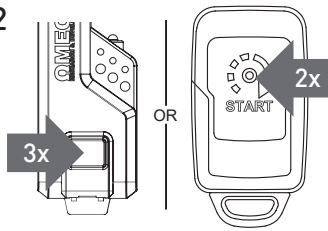
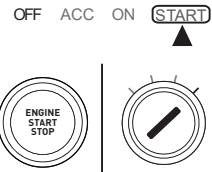
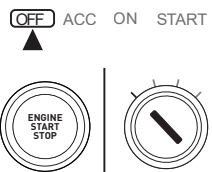
- 1** OFF ACC **ON** START  
Turn ignition to ON position (do not start).
- 
- 
- 2** Within 5 seconds of step 1 press the Valet button 3x or send remote start command (by remote, Linkr, activation input wire etc.).
- 
- The system will chirp & flash lights to indicate crank delay [Default: 1 chirp/flash = 1.5 sec]
  - Press valet button to change crank delay
  - Chirps: 1=1.5 sec, 2=15 sec, 3=20 sec, 4=30 sec
- 
- 3** OFF ACC ON **START**  
Start the engine with the key and let the engine reach normal idle.
- 
- 
- 4** OFF ACC ON START  
Release the parking brake.
- 
- MANUAL TRANSMISSIONS:**  
Release the parking brake.
- AUTOMATIC TRANSMISSIONS:**  
Turn the ignition key OFF.
- The system will chirp & flash the lights equal the # of IGN/ACC/START circuits detected (Max: 4).
- MANUAL** - Proceed to step 5.  
**AUTOMATIC** - Skip to step 6.

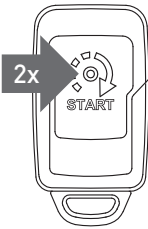
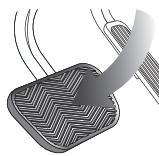
- 5** **BRAKE**  
**MANUAL TRANSMISSIONS:**  
Set the parking brake again to enter Manual Transmission Reservation Mode option selection. (installer feature #11)
- 
- The system will chirp & flash the light to indicate current setting (default: 2 - Off)
  - Set and Release the parking brake to scroll through setting options.
  - Chirp confirmation: 1 = **ON** - Shutdown w/ lock, 2 = **OFF**, 3 = **ON** - Shutdown w/ door close, 4 = **ON** - Shutdown 10 sec. after door close
  - Before turning the key OFF, perform the MT reservation sequence (see operation guide) and exit the vehicle.
- 
- 6** Activate remote start (within 60 sec. of Step 4 or 5). Wait until engine is running and LED flashes slowly (10-45 seconds after engine cranks & runs).  
**Push-to-Start vehicles:** Ensure the OEM fob is at least 20 ft. away to allow remote start.
- 
- The system will detect data protocols, select the best available engine running detection method, and, learn any available tach input (data or analog).
- 
- 7** **TO SAVE SETTINGS/FINISH VEHICLE LEARN:**  
Press the BRAKE pedal (will shut down RS).
- 
- This disables VEHICLE LEARN (to enable again, program installer feature #2 (bank 10) to "Enabled".
- TO CANCEL/START OVER:**  
Press the valet button once.
- 
- 8** Programming complete.

## Troubleshooting

- See system installation guide for remote start diagnostics and troubleshooting.
- See OmegaLink module/firmware guide at [www.wiresheet.com](http://www.wiresheet.com) for interface module diagnostics and troubleshooting.

## RS-X70 Layout

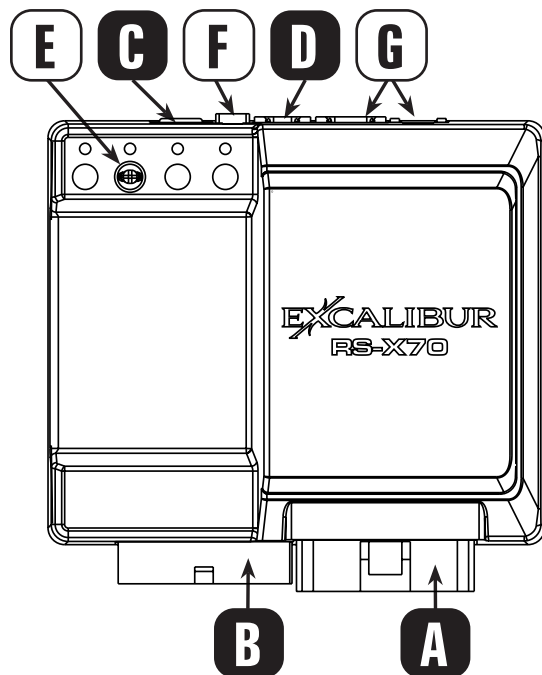

- A** WHITE 6 PIN HIGH CURRENT POWER HARNESS (P/N: H-RS6E\*)
- B** WHITE 14 PIN MAIN INPUT/OUTPUT HARNESS (P/N: H-RS14A)
- C** RED 3 PIN DOOR LOCK/UNLOCK HARNESS (P/N: DLP-N3)
- D** RED 3 PIN REMOTE START HARNESS (P/N: RS-OUTPUT)
- E** TEMPERATURE SENSOR - **DO NOT COVER**  
(For high/low temp auto start and for automatic low temp crank extender)
- F** ANTENNA / STATUS LIGHT / VALET PORT - Supports compatible plug-in antennas or push-button status light  
(P/N: AU-LED-PB2)
- G** GREEN & BLACK DATA PORTS - For Telematics / Data Sensor (Shock, Tilt, etc) / Vehicle Interface Module.  
(DBI & iDatalink protocols supported on both ports - see 'Vehicle Learn' or installer feature #12)

## RS-X70 Installation Steps

### INSTALLATION STEPS:

- 1) Go to [www.OmegaWeblink.com](http://www.OmegaWeblink.com) or use WebLink Mobile to flash the bypass module with the firmware matching the vehicle.  
NOTE: iDatalink 2-way protocol is recommended for full functionality.  
NOTE: If OEM remote is being used to activate the remote start be sure "Factory keyless RS sequence" is set to "Lock + Lock + Lock" OR "Lock + Unlock + Lock"
- 2) Make all the connections shown in the diagram on the following pages.
- 3) Connect any optional hardware as needed.
- 4) Select Data Mode and program the bypass module to the vehicle (see module programming instructions).
- 5) Perform Vehicle Learn to configure the remote start to match the vehicle.  
**NOTE: If Vehicle Learn is not performed remote start operation could fail.**
- 6) Test the system for all desired functions.

**NOTE:** Any features NOT supported by the interface module must be hard wired from the remote start to the vehicle. Refer to the remote start install guide and vehicle wiring info at [www.wiresheet.com](http://www.wiresheet.com) (only available for authorized dealers) for instructions.

## MODEL: OL-HRN-RS-NI4

### Wire Location Chart Diagram #1

Make	Model	Trim	Year	Item	Connector Color	Connector Pins	Pin #	Wire Color	Polarity	Location
Infiniti	QX56	Std. Key Automatic (w/o alarm)	2005 - 2009	Parking Lights	White	24	12	RED/BLUE	(+)	Drivers Kick Panel
				Horn Honk	GRAY	8	2	RED/WHITE	(-)	Horn Switch Top of Steering Column
Nissan	350Z	Std. Key Automatic (w/o alarm)	2006 - 2009	Parking Lights	-	-	-	RED/BLUE	(+)	Drivers Kick Panel
				Horn Honk	GRAY	8	2	GREEN/BLACK	(-)	Horn Switch Top of Steering Column
Nissan	Altima	Std. Key Automatic (w/o alarm)	2005 - 2006	Parking Lights	-	-	-	RED/BLUE	(+)	Drivers Kick Panel
				Horn Honk	-	-	-	GREEN/WHITE	(-)	Horn Switch Top of Steering Column
Nissan	Armada	Std. Key Automatic (w/o alarm)	2005 - 2015	Parking Lights	White	24	12	RED/BLUE	(+)	Drivers Kick Panel
				Horn Honk	GRAY	8	2	RED/WHITE	(-)	Horn Switch Top of Steering Column
Nissan	Cube	Std. Key Automatic (w/o alarm)	2009 - 2014	Parking Lights	WHITE	16	13	BROWN/WHITE	(+)	Drivers Kick Panel
				Horn Honk	-	-	-	RED/BLACK	(-)	Horn Switch Top of Steering Column
Nissan	Frontier	Std. Key Automatic (w/o alarm)	2005 - 2019	Parking Lights	WHITE	6	4	RED	(+)	Electric Brake Plug Behind OBDII Plug
				Horn Honk	-	-	-	BROWN or RED	(-)	Horn Switch Top of Steering Column
Nissan	Juke	Std. Key Automatic (w/o alarm)	2011 - 2017	Parking Lights	WHITE	100	70	VIOLET	(+)	Drivers Kick Panel
				Horn Honk	GRAY	8	8	RED or LT. GREEN	(-)	Horn Switch Top of Steering Column
Nissan	Maxima	Std. Key Automatic (w/o alarm)	2007 - 2008	Parking Lights	-	-	-	RED/BLUE	(+)	Drivers Kick Panel
				Horn Honk	GRAY	8	2	RED	(-)	Horn Switch Top of Steering Column
Nissan	Maxima	Std. Key Automatic (w/o alarm)	2004 - 2006	Parking Lights	-	-	-	RED/BLUE	(+)	Drivers Kick Panel
				Horn Honk	GRAY	8	2	GREEN/WHITE	(-)	Horn Switch Top of Steering Column
Nissan	Pathfinder	Std. Key Automatic (w/o alarm)	2005 - 2012	Parking Lights	GRAY	8	1	GRAY	(+)	Drivers Kick Panel
				Horn Honk	WHITE	16	9	BROWN	(-)	Drivers Kick Panel
Nissan	Quest	Std. Key Automatic (w/o alarm)	2004 - 2009	Parking Lights	-	-	-	RED/BLUE	(+)	Drivers Kick Panel
				Horn Honk	-	-	-	GREEN/WHITE	(-)	Horn Switch Top of Steering Column
Nissan	Rogue	Std. Key Automatic (w/o alarm)	2008 - 2013	Parking Lights	-	-	-	RED	(+)	Drivers Kick Panel
				Horn Honk	-	-	-	GRAY	(-)	Horn Switch Top of Steering Column
Nissan	Rogue Select	Std. Key Automatic (w/o alarm)	2014 - 2015	Parking Lights	-	-	-	RED	(+)	Drivers Kick Panel
				Horn Honk	-	-	-	GRAY	(-)	Horn Switch Top of Steering Column
Nissan	Sentra	Std. Key Automatic (w/o alarm)	2007 - 2012	Parking Lights	GRAY	16	4	RED	(+)	Right Side Of Fuse Box
				Horn Honk	GRAY	8	3	GREEN	(-)	Horn Switch Top of Steering Column
Nissan	Titan	Std. Key Automatic (w/o alarm)	2005 - 2015	Parking Lights	WHITE	6	4	RED/BLUE	(+)	Electric Brake Plug Left Of Column
				Horn Honk	GRAY	8	2	RED/WHITE	(-)	Horn Switch Top of Steering Column
Nissan	Versa	Std. Key Automatic (w/o alarm)	2007 - 2019	Parking Lights	GRAY	16	4	RED	(+)	Drivers Kick Panel
				Horn Honk	GRAY	8	5	RED	(-)	Horn Switch Top of Steering Column

**Wire Location Chart Diagram #1**

Make	Model	Trim	Year	Item	Connector Color	Connector Pins	Pin #	Wire Color	Polarity	Location
Nissan	Xterra	Std. Key Automatic (w/o alarm)	2005 - 2015	Parking Lights	GRAY	8	1	GRAY	(+)	Drivers Kick Panel
				Horn Honk	WHITE	16	9	BROWN	(-)	Drivers Kick Panel
Suzuki	Equator	Std. Key Automatic (w/o alarm)	2009 - 2011	Parking Lights	GRAY	8	1	GRAY	(+)	Drivers Kick Panel
				Horn Honk	WHITE	16	9	BROWN	(-)	Drivers Kick Panel

## RS-X70 Diagram #1

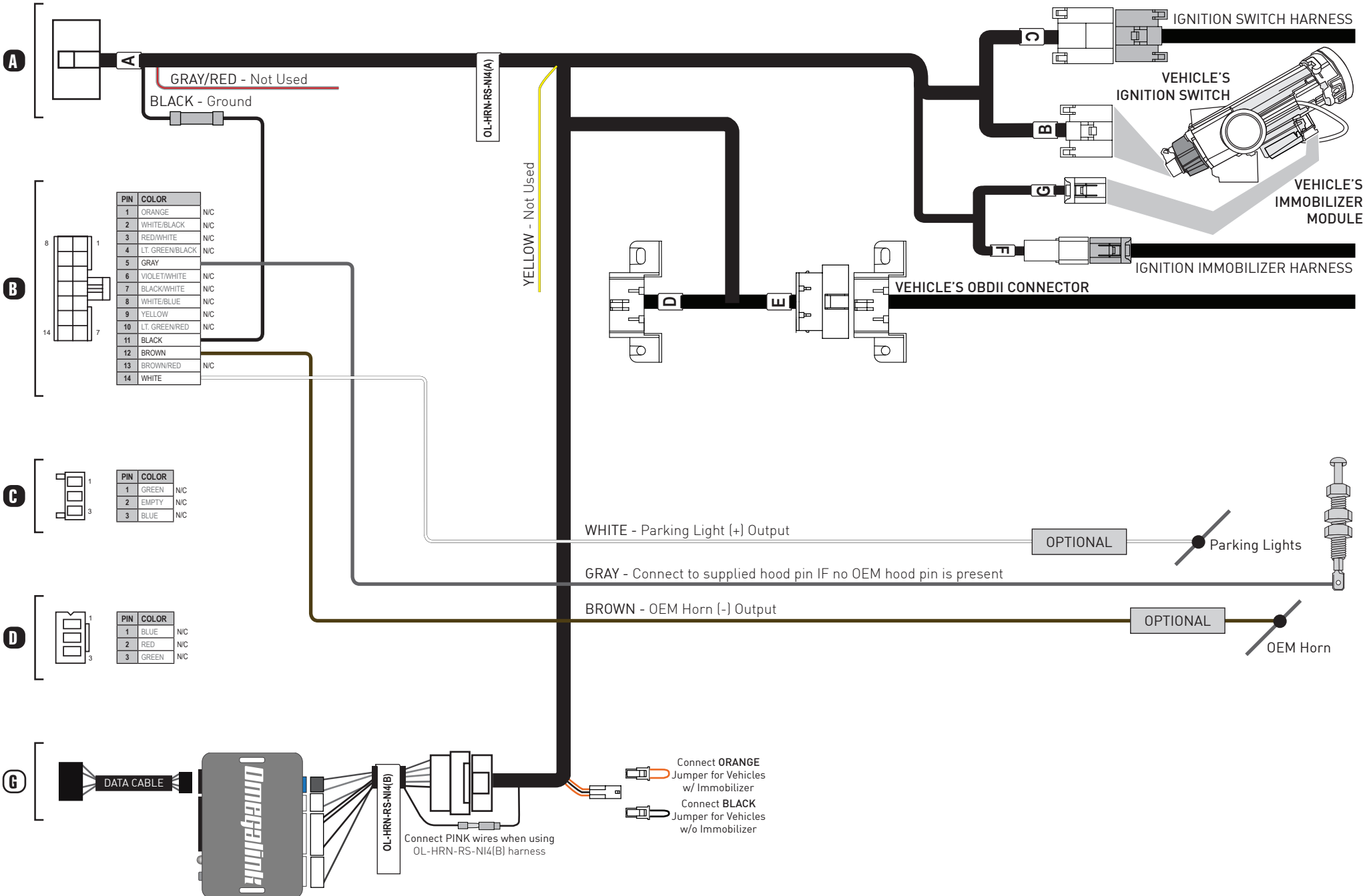

## Wire Location Chart Diagram #2

Make	Model	Trim	Year	Item	Connector Color	Connector Pins	Pin #	Wire Color	Polarity	Location
Chevrolet	City Express	Std. Key Automatic	2015 - 2018	OEM Arm/Lock	WHITE	12	4	PINK	(-)	Drivers Kick Harness From Door
				OEM Disarm/Unlock	WHITE	12	7	BLACK	(-)	Drivers Kick Harness From Door
				Parking Lights	-	-	-	VIOLET	(+)	Drivers Firewall Harness
				Horn Honk	GRAY	8	5	RED	(-)	Horn Switch Top of Steering Column
Infiniti	QX56	Std. Key Automatic (w/ alarm)	2005 - 2009	OEM Arm/Lock	WHITE	40	8	INSERT PIN *	(-)	BCM Right Side Of Column
				OEM Disarm/Unlock	WHITE	40	7	INSERT PIN *	(-)	BCM Right Side Of Column
				Parking Lights	White	24	12	RED/BLUE	(+)	Drivers Kick Panel
				Horn Honk	GRAY	8	2	RED/WHITE	(-)	Horn Switch Top of Steering Column
Nissan	350Z	Std. Key Automatic (w/ alarm)	2006 - 2009	OEM Arm/Lock	WHITE	40	8	INSERT PIN *	(-)	BCM Drivers Kick Panel
				OEM Disarm/Unlock	WHITE	40	7	INSERT PIN *	(-)	BCM Drivers Kick Panel
				Parking Lights	-	-	-	RED/BLUE	(+)	Drivers Kick Panel
				Horn Honk	GRAY	8	2	GREEN/BLACK	(-)	Horn Switch Top of Steering Column
Nissan	Altima	Std. Key Automatic (w/ alarm)	2005 - 2006	OEM Arm/Lock	WHITE	40	8	INSERT PIN *	(-)	BCM Right Side Of Fuse Box
				OEM Disarm/Unlock	WHITE	40	7	INSERT PIN *	(-)	BCM Right Side Of Fuse Box
				Parking Lights	-	-	-	RED/BLUE	(+)	Drivers Kick Panel
				Horn Honk	-	-	-	GREEN/WHITE	(-)	Horn Switch Top of Steering Column
Nissan	Armada	Std. Key Automatic (w/ alarm)	2005 - 2015	OEM Arm/Lock	WHITE	40	8	INSERT PIN *	(-)	BCM Right Side Of Column
				OEM Disarm/Unlock	WHITE	40	7	INSERT PIN *	(-)	BCM Right Side Of Column
				Parking Lights	White	24	12	RED/BLUE	(+)	Drivers Kick Panel
				Horn Honk	GRAY	8	2	RED/WHITE	(-)	Horn Switch Top of Steering Column
Nissan	Cube	Std. Key Automatic (w/ alarm)	2009 - 2014	OEM Arm/Lock	WHITE	40	8	WHITE/BLACK	(-)	BCM Right Side Of Fuse Box
				OEM Disarm/Unlock	WHITE	40	7	WHITE/RED	(-)	BCM Right Side Of Fuse Box
				Parking Lights	WHITE	16	13	BROWN/WHITE	(+)	Drivers Kick Panel
				Horn Honk	-	-	-	RED/BLACK	(-)	Horn Switch Top of Steering Column
Nissan	Frontier	Std. Key Automatic (w/ alarm))	2005 - 2019	OEM Arm/Lock	-	-	-	LT. BLUE	(-)	Drivers Kick Panel Harness From Door
				OEM Disarm/Unlock	-	-	-	GRAY	(-)	Drivers Kick Panel Harness From Door
				Parking Lights	WHITE	6	4	RED	(+)	Electric Brake Plug Behind ODBII Plug
				Horn Honk	-	-	-	BROWN or RED	(-)	Horn Switch Top of Steering Column
Nissan	Juke	Std. Key Automatic (w/ alarm)	2011 - 2017	OEM Arm/Lock	-	-	-	RED	(-)	Drivers Kick Panel Harness From Door
				OEM Disarm/Unlock	-	-	-	BLUE	(-)	Drivers Kick Panel Harness From Door
				Parking Lights	WHITE	100	70	VIOLET	(+)	Drivers Kick Panel
				Horn Honk	GRAY	8	8	RED or LT. GREEN	(-)	Horn Switch Top of Steering Column
Nissan	Maxima	Std. Key Automatic (w/ alarm)	2007 - 2008	OEM Arm/Lock	WHITE	40	8	INSERT PIN *	(-)	BCM Right Side Of Fuse Box
				OEM Disarm/Unlock	WHITE	40	7	INSERT PIN *	(-)	BCM Right Side Of Fuse Box
				Parking Lights	-	-	-	RED/BLUE	(+)	Drivers Kick Panel
				Horn Honk	GRAY	8	2	RED	(-)	Horn Switch Top of Steering Column

\* See diagram on page 4 for Insert Pin instructions.

## Wire Location Chart Diagram #2

Make	Model	Trim	Year	Item	Connector Color	Connector Pins	Pin #	Wire Color	Polarity	Location
Nissan	Maxima	Std. Key Automatic (w/ alarm)	2004 - 2006	OEM Arm/Lock	WHITE	40	8	INSERT PIN *	(-)	BCM Right Side Of Fuse Box
				OEM Disarm/Unlock	WHITE	40	7	INSERT PIN *	(-)	BCM Right Side Of Fuse Box
				Parking Lights	-	-	-	RED/BLUE	(+)	Drivers Kick Panel
				Horn Honk	GRAY	8	2	GREEN/WHITE	(-)	Horn Switch Top of Steering Column
Nissan	Micra	Std. Key Automatic	2015 - 2019	OEM Arm/Lock	WHITE	40	8	GRAY	(-)	BCM Drivers Kick Panel
				OEM Disarm/Unlock	WHITE	40	7	WHITE	(-)	BCM Drivers Kick Panel
				Parking Lights	GRAY	16	4	RED	(+)	Drivers Kick Panel
				Horn Honk	GRAY	8	5	RED	(-)	Horn Switch Top of Steering Column
Nissan	NV 200	Std. Key Automatic	2013 - 2021	OEM Arm/Lock	WHITE	12	4	PINK	(-)	Drivers Kick Harness From Door
				OEM Disarm/Unlock	WHITE	12	7	BLACK	(-)	Drivers Kick Harness From Door
				Parking Lights	-	-	-	VIOLET	(+)	Drivers Firewall Harness
				Horn Honk	GRAY	8	5	RED	(-)	Horn Switch Top of Steering Column
Nissan	NV 1500	Std. Key Automatic	2012 - 2021	OEM Arm/Lock	-	-	-	LT. BLUE	(-)	Drivers Kick Harness From Door
				OEM Disarm/Unlock	-	-	-	YELLOW	(-)	Drivers Kick Harness From Door
				Parking Lights	WHITE	4	3	RED	(+)	Drivers Kick Panel
				Horn Honk	WHITE	16	14	WHITE	(-)	Drivers Kick Panel
Nissan	NV 2500	Std. Key Automatic	2012 - 2021	OEM Arm/Lock	-	-	-	LT. BLUE	(-)	Drivers Kick Harness From Door
				OEM Disarm/Unlock	-	-	-	YELLOW	(-)	Drivers Kick Harness From Door
				Parking Lights	WHITE	4	3	RED	(+)	Drivers Kick Panel
				Horn Honk	WHITE	16	14	WHITE	(-)	Drivers Kick Panel
Nissan	NV 3500	Std. Key Automatic	2012 - 2021	OEM Arm/Lock	-	-	-	LT. BLUE	(-)	Drivers Kick Harness From Door
				OEM Disarm/Unlock	-	-	-	YELLOW	(-)	Drivers Kick Harness From Door
				Parking Lights	WHITE	4	3	RED	(+)	Drivers Kick Panel
				Horn Honk	WHITE	16	14	WHITE	(-)	Drivers Kick Panel
Nissan	Pathfinder	Std. Key Automatic (w/ alarm)	2005 - 2012	OEM Arm/Lock	WHITE	40	8	INSERT PIN *	(-)	BCM Right Side Of Column
				OEM Disarm/Unlock	WHITE	40	7	INSERT PIN *	(-)	BCM Right Side Of Column
				Parking Lights	GRAY	8	1	GRAY	(+)	Drivers Kick Panel
				Horn Honk	WHITE	16	9	BROWN	(-)	Drivers Kick Panel
Nissan	Quest	Std. Key Automatic (w/ alarm))	2004 - 2009	OEM Arm/Lock	WHITE	40	8	INSERT PIN *	(-)	BCM Left Os Steering Column
				OEM Disarm/Unlock	WHITE	40	7	INSERT PIN *	(-)	BCM Left Os Steering Column
				Parking Lights	-	-	-	RED/BLUE	(+)	Drivers Kick Panel
				Horn Honk	-	-	-	GREEN/WHITE	(-)	Horn Switch Top of Steering Column
Nissan	Rogue	Std. Key Automatic (w/ alarm)	2008 - 2013	OEM Arm/Lock	-	-	-	RED	(-)	Drivers Kick Harness From Door
				OEM Disarm/Unlock	-	-	-	BLUE	(-)	Drivers Kick Harness From Door
				Parking Lights	-	-	-	RED	(+)	Drivers Kick Panel
				Horn Honk	-	-	-	GRAY	(-)	Horn Switch Top of Steering Column

\* See diagram on page 4 for Insert Pin instructions.

## MODEL: OL-HRN-RS-NI4

### Wire Location Chart Diagram #2

Make	Model	Trim	Year	Item	Connector Color	Connector Pins	Pin #	Wire Color	Polarity	Location
Nissan	Sentra	Std. Key Automatic	2007 - 2012	OEM Arm/Lock	-	-	-	BROWN	(-)	Drivers Kick Harness From Door
				OEM Disarm/Unlock	-	-	-	WHITE	(-)	Drivers Kick Harness From Door
				Parking Lights	GRAY	16	4	RED	(+)	Right Side Of Fuse Box
				Horn Honk	GRAY	8	3	GREEN	(-)	Horn Switch Top of Steering Column
Nissan	Sentra	Std. Key Automatic	2013 - 2019	OEM Arm/Lock	-	-	-	VIOLET	(-)	Drivers Kick Harness From Door
				OEM Disarm/Unlock	-	-	-	BLUE	(-)	Drivers Kick Harness From Door
				Parking Lights	GRAY	16	4	RED	(+)	Right Side Of Fuse Box
				Horn Honk	GRAY	8	3	GREEN	(-)	Horn Switch Top of Steering Column
Nissan	Titan	Std. Key Automatic (w/ alarm)	2005 - 2015	OEM Arm/Lock	WHITE	40	8	INSERT PIN *	(-)	BCM Right Side Of Column
				OEM Disarm/Unlock	WHITE	40	7	INSERT PIN *	(-)	BCM Right Side Of Column
				Parking Lights	WHITE	6	4	RED/BLUE	(+)	Electric Brake Plug Left Of Column
				Horn Honk	GRAY	8	2	RED/WHITE	(-)	Horn Switch Top of Steering Column
Nissan	Versa	Std. Key Automatic (w/ alarm)	2007 - 2019	OEM Arm/Lock	-	-	-	GRAY	(-)	Drivers Kick Harness From Door
				OEM Disarm/Unlock	-	-	-	WHITE	(-)	Drivers Kick Harness From Door
				Parking Lights	GRAY	16	4	RED	(+)	Drivers Kick Panel
				Horn Honk	GRAY	8	5	RED	(-)	Horn Switch Top of Steering Column
Nissan	Versa Note	Std. Key Automatic	2014 - 2018	OEM Arm/Lock	-	-	-	GRAY	(-)	Drivers Kick Harness From Door
				OEM Disarm/Unlock	-	-	-	WHITE	(-)	Drivers Kick Harness From Door
				Parking Lights	WHITE	24	3	RED	(+)	Drivers Kick Panel
				Horn Honk	YELLOW	8	5	RED	(-)	Horn Switch Top of Steering Column
Nissan	Xterra	Std. Key Automatic (w/ alarm)	2005 - 2015	OEM Arm/Lock	-	-	-	LT. BLUE	(-)	Drivers Kick Panel
				OEM Disarm/Unlock	-	-	-	GRAY	(-)	Drivers Kick Panel
				Parking Lights	GRAY	8	1	GRAY	(+)	Drivers Kick Panel
				Horn Honk	WHITE	16	9	BROWN	(-)	Drivers Kick Panel
Suzuki	Equator	Std. Key Automatic (w/ alarm)	2009 - 2011	OEM Arm/Lock	-	-	-	LT. BLUE	(-)	Drivers Kick Panel
				OEM Disarm/Unlock	-	-	-	GRAY	(-)	Drivers Kick Panel
				Parking Lights	GRAY	8	1	GRAY	(+)	Drivers Kick Panel
				Horn Honk	WHITE	16	9	BROWN	(-)	Drivers Kick Panel

\* See diagram on page 4 for Insert Pin instructions.

## MODEL: OL-HRN-RS-NI4

### RS-X70 Diagram #2

**INSTALLER Feature #8 MUST be programmed to Double Unlock (Option #3).**  
See RS-X70 Installation Guide for programming procedure.

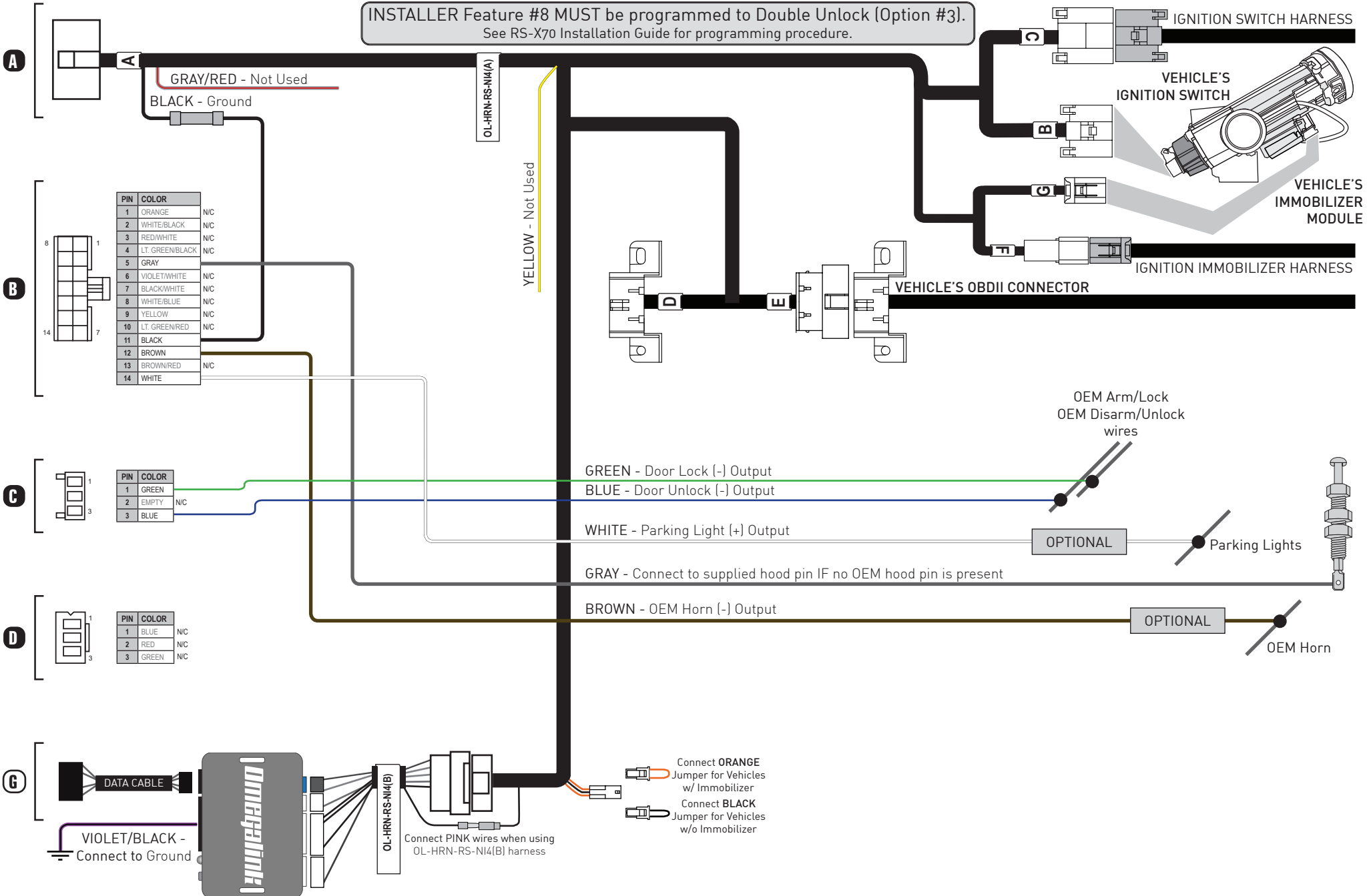

## Wire Location Chart Diagram #3

Make	Model	Trim	Year	Item	Connector Color	Connector Pins	Pin #	Wire Color	Polarity	Location
Infiniti	QX56	W/ Intelli-Key Automatic	2008 - 2010	Intelli-Key Ignition	WHITE	40	6	GREEN/RED	(+)	Intelli-Key Module Behind Gauge Cluster
				Keysense	GRAY	6	4	BLACK/RED	(+)	Ignition Switch
				Parking Lights	White	24	12	RED/BLUE	(+)	Drivers Kick Panel
				Horn Honk	GRAY	8	2	RED/WHITE	(-)	Horn Switch Top of Steering Column
Nissan	Armada	W/ Intelli-Key Automatic	2008 - 2015	Intelli-Key Ignition	WHITE	40	6	GREEN/RED	(+)	Intelli-Key Module Behind Gauge Cluster
				Keysense	GRAY	6	4	BLACK/RED	(+)	Ignition Switch
				Parking Lights	White	24	12	RED/BLUE	(+)	Drivers Kick Panel
				Horn Honk	GRAY	8	2	RED/WHITE	(-)	Horn Switch Top of Steering Column
Nissan	Maxima	W/ Intelli-Key Automatic	2007 - 2008	Intelli-Key Ignition	WHITE	40	6	GREEN	(+)	Intelli-Key Module Right Of Steering Column
				Keysense	GRAY	6	4	RED/BLACK	(+)	Ignition Switch
				Parking Lights	-	-	-	RED/BLUE	(+)	Drivers Kick Panel
				Horn Honk	GRAY	8	2	RED	(-)	Horn Switch Top of Steering Column
Nissan	Pathfinder	W/ Intelli-Key Automatic	2008 - 2012	Intelli-Key Ignition	WHITE	40	6	WHITE/GREEN	(+)	Intelli-Key Module Behind Glove Box
				Keysense	GRAY	6	4	LT. BLUE	(+)	Ignition Switch
				Parking Lights	GRAY	8	1	GRAY	(+)	Drivers Kick Panel
				Horn Honk	WHITE	16	9	BROWN	(-)	Drivers Kick Panel
Nissan	Rogue	W/ Intelli-Key Automatic	2008 - 2013	Intelli-Key Ignition	WHITE	40	6	WHITE	(+)	Intelli-Key Module Behind Power Mirror Switch
				Keysense	GRAY	6	1	LT. GREEN	(+)	Ignition Switch
				Parking Lights	-	-	-	RED	(+)	Drivers Kick Panel
				Horn Honk	-	-	-	GRAY	(-)	Horn Switch Top of Steering Column
Nissan	Rogue Select	W/ Intelli-Key Automatic	2014 - 2015	Intelli-Key Ignition	WHITE	40	6	WHITE	(+)	Intelli-Key Module Behind Power Mirror Switch
				Keysense	GRAY	6	1	LT. GREEN	(+)	Ignition Switch
				Parking Lights	-	-	-	RED	(+)	Drivers Kick Panel
				Horn Honk	-	-	-	GRAY	(-)	Horn Switch Top of Steering Column
Nissan	Sentra	W/ Intelli-Key Automatic	2007 - 2012	Intelli-Key Ignition	WHITE	40	6	BROWN	(+)	Intelli-Key Module Behind Glove Box
				Keysense	GRAY	6	1	VIOLET	(+)	Ignition Switch
				Parking Lights	GRAY	16	4	RED	(+)	Right Side Of Fuse Box
				Horn Honk	GRAY	8	3	GREEN	(-)	Horn Switch Top of Steering Column
Nissan	Versa	W/ Intelli-Key Automatic	2007 - 2011	Intelli-Key Ignition	WHITE	40	6	YELLOW	(+)	Intelli-Key Module Behind Glove Box
				Keysense	GRAY	6	1	LT. GREEN	(+)	Ignition Switch
				Parking Lights	GRAY	16	4	RED	(+)	Drivers Kick Panel
				Horn Honk	GRAY	8	5	RED	(-)	Horn Switch Top of Steering Column

## MODEL: OL-HRN-RS-NI4

### RS-X70 Diagram #3

**INSTALLER Feature #6 MUST be programmed to GWR/Status (Option #2).**  
See RS-X70 Installation Guide for programming procedure.

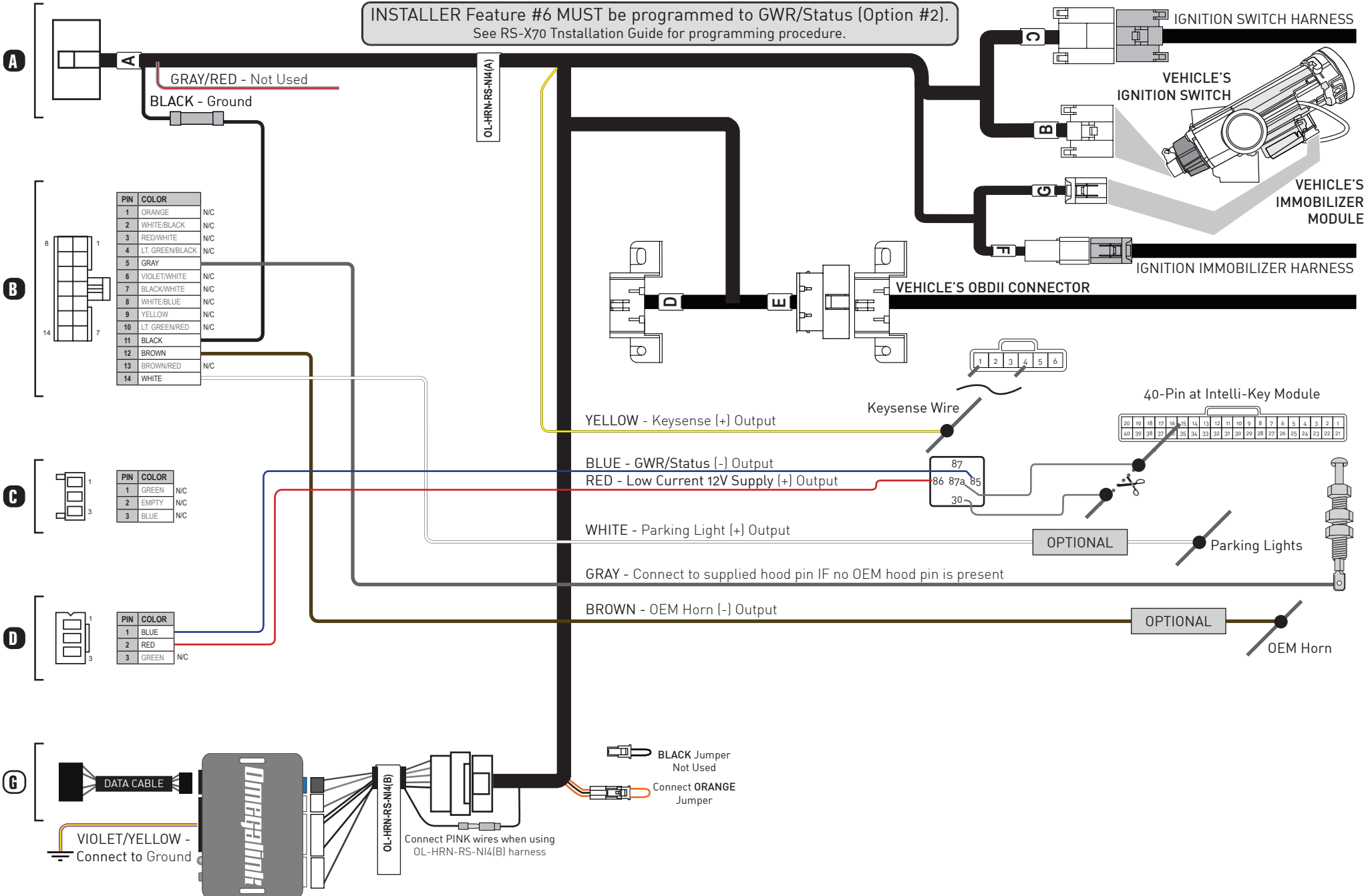

## Wire Location Chart Diagram #4

Make	Model	Trim	Year	Item	Connector Color	Connector Pins	Pin #	Wire Color	Polarity	Location
Nissan	Altima	Std. Key Manual (w/o alarm)	2005 - 2006	Parking Lights	-	-	-	RED/BLUE	(+)	Drivers Kick Panel
				Horn Honk	-	-	-	GREEN/WHITE	(-)	Horn Switch Top of Steering Column
				Clutch Bypass	BLUE	2	1	GREEN/RED	(-)	Clutch Switch
				Parking Brake	-	1	1	GREEN	(-)	Parking Brake Switch
Nissan	Cube	Std. Key Manual (w/o alarm)	2009 - 2014	Parking Lights	WHITE	16	13	BROWN/WHITE	(+)	Drivers Kick Panel
				Horn Honk	-	-	-	RED/BLACK	(-)	Horn Switch Top of Steering Column
				Clutch Bypass	WHITE	4	4	BROWN	(+)	Clutch Switch
				Parking Brake	BLACK	1	1	LT. BLUE	(-)	Parking Brake Switch
Nissan	Frontier	Std. Key Manual (w/o alarm)	2005 - 2019	Parking Lights	WHITE	6	4	RED	(+)	Electric Brake Plug Behind Obd-ii Plug
				Horn Honk	-	-	-	BROWN or RED	(-)	Horn Switch Top of Steering Column
				Clutch Bypass	BLUE	2	2	RED or BLUE	(+)	Clutch Switch
				Parking Brake	-	-	-	GREEN	(-)	Parking Brake Switch
Nissan	Juke	Std. Key Manual (w/o alarm)	2011 - 2017	Parking Lights	WHITE	100	70	VIOLET	(+)	Drivers Kick Panel
				Horn Honk	GRAY	8	8	RED or LT. GREEN	(-)	Horn Switch Top of Steering Column
				Clutch Bypass	WHITE	4	4	BROWN	(+)	Clutch Switch
				Parking Brake	BLACK	1	1	LT. BLUE	(-)	Parking Brake Switch
Nissan	Maxima	Std. Key Manual (w/o alarm)	2004 - 2006	Parking Lights	-	-	-	RED/BLUE	(+)	Drivers Kick Panel
				Horn Honk	GRAY	8	2	GREEN/WHITE	(-)	Horn Switch Top of Steering Column
				Clutch Bypass	BLUE	2	1	GREEN/RED	(-)	Clutch Switch
				Parking Brake	BLACK	1	1	PINK/BLACK	(-)	Parking Brake Switch
Nissan	Sentra	Std. Key Manual (w/o alarm)	2007 - 2012	Parking Lights	GRAY	16	4	RED	(+)	Right Side Of Fuse Box
				Horn Honk	GRAY	8	3	GREEN	(-)	Horn Switch Top of Steering Column
				Clutch Bypass	BROWN	2	1	BROWN/RED	(+)	Clutch Switch
				Parking Brake	-	-	-	GREEN	(-)	Parking Brake Switch or Passenger Kick
Nissan	Versa	Std. Key Manual (w/o alarm)	2007 - 2019	Parking Lights	GRAY	16	4	RED	(+)	Drivers Kick Panel
				Horn Honk	GRAY	8	5	RED	(-)	Horn Switch Top of Steering Column
				Clutch Bypass	BROWN	2	2	LT. GREEN	(+)	Clutch Switch
				Parking Brake	BLACK	1	1	LT. BLUE	(-)	Parking Brake Switch
Nissan	Xterra	Std. Key Manual (w/o alarm)	2005 - 2015	Parking Lights	GRAY	8	1	GRAY	(+)	Drivers Kick Panel
				Horn Honk	WHITE	16	9	BROWN	(-)	Drivers Kick Panel
				Clutch Bypass	BLUE	2	2	RED or BLUE	(+)	Clutch Switch
				Parking Brake	-	-	-	GREEN	(-)	Parking Brake Switch
Suzuki	Equator	Std. Key Manual (w/o alarm)	2009 - 2011	Parking Lights	GRAY	8	1	GRAY	(+)	Drivers Kick Panel
				Horn Honk	WHITE	16	9	BROWN	(-)	Drivers Kick Panel
				Clutch Bypass	BLUE	2	2	RED or BLUE	(+)	Clutch Switch
				Parking Brake	-	-	-	GREEN	(-)	Parking Brake Switch

## MODEL: OL-HRN-RS-NI4

### RS-X70 Diagram #4

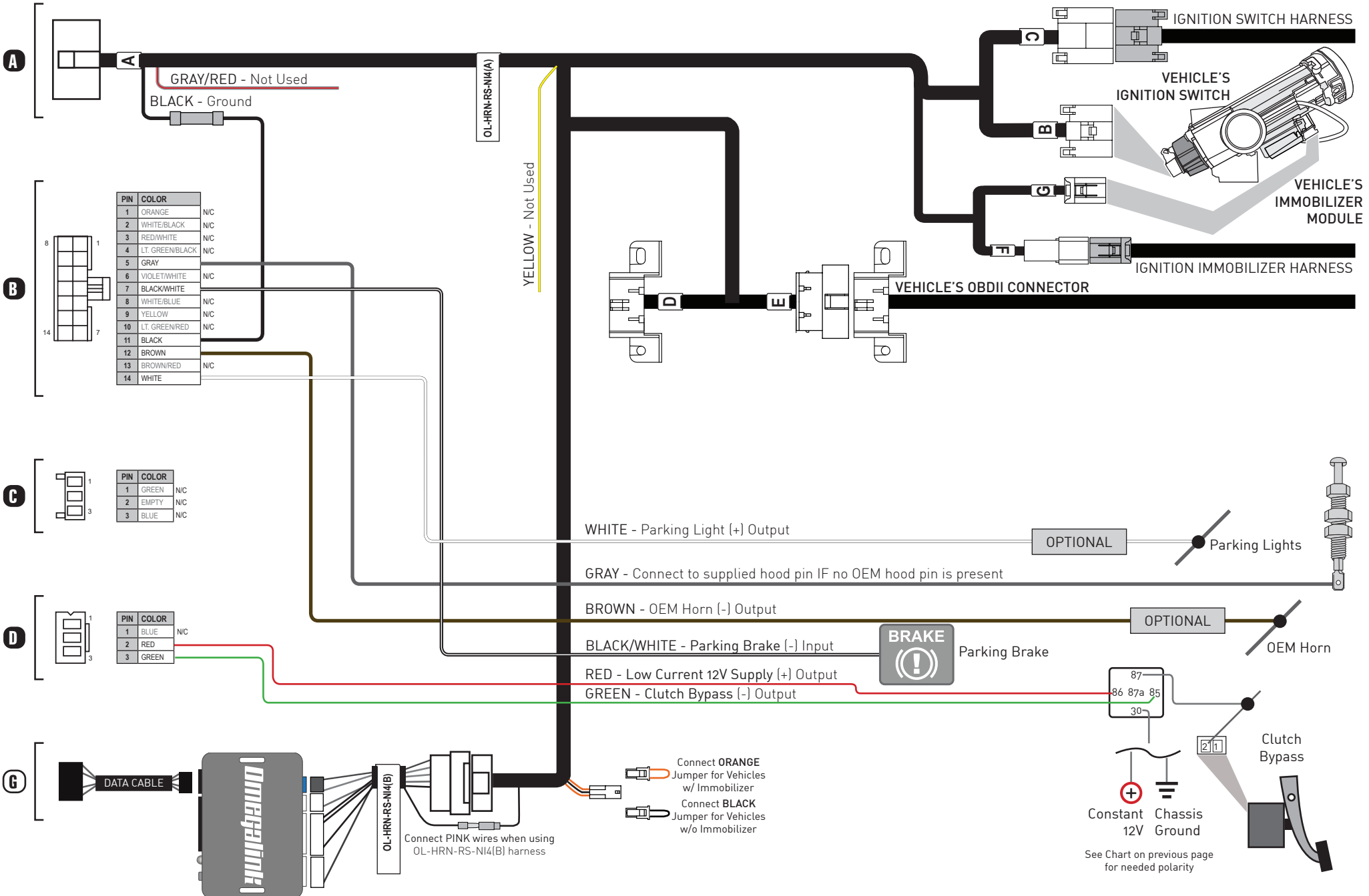

## Wire Location Chart Diagram #5

Make	Model	Trim	Year	Item	Connector Color	Connector Pins	Pin #	Wire Color	Polarity	Location
Nissan	Altima	Std. Key Manual (w/ alarm)	2005 - 2006	OEM Arm/Lock	WHITE	40	8	INSERT PIN *	(-)	BCM Right Side Of Fuse Box
				OEM Disarm/Unlcok	WHITE	40	7	INSERT PIN *	(-)	BCM Right Side Of Fuse Box
				Parking Lights	-	-	-	RED/BLUE	(+)	Drivers Kick Panel
				Horn Honk	-	-	-	GREEN/WHITE	(-)	Horn Switch Top of Steering Column
				Clutch Bypass	BLUE	2	1	GREEN/RED	(-)	Clutch Switch
				Parking Brake	-	1	1	GREEN	(-)	Parking Brake Switch
Nissan	Frontier	Std. Key Manual (w/ alarm)	2005 - 2019	OEM Arm/Lock	-	-	-	LT. BLUE	(-)	Drivers Kick Panel Harness From Door
				OEM Disarm/Unlcok	-	-	-	GRAY	(-)	Drivers Kick Panel Harness From Door
				Parking Lights	WHITE	6	4	RED	(+)	Electric Brake Plug Behind Obd-ii Plug
				Horn Honk	-	-	-	BROWN or RED	(-)	Horn Switch Top of Steering Column
				Clutch Bypass	BLUE	2	2	RED or BLUE	(+)	Clutch Switch
				Parking Brake	-	-	-	GREEN	(-)	Parking Brake Switch
Nissan	Juke	Std. Key Manual (w/ alarm)	2011 - 2017	OEM Arm/Lock	-	-	-	RED	(-)	Drivers Kick Panel Harness From Door
				OEM Disarm/Unlcok	-	-	-	BLUE	(-)	Drivers Kick Panel Harness From Door
				Parking Lights	WHITE	100	70	VIOLET	(+)	Drivers Kick Panel
				Horn Honk	GRAY	8	8	RED or LT. GREEN	(-)	Horn Switch Top of Steering Column
				Clutch Bypass	WHITE	4	4	BROWN	(+)	Clutch Switch
				Parking Brake	BLACK	1	1	LT. BLUE	(-)	Parking Brake Switch
Nissan	Maxima	Std. Key Manual (w/ alarm)	2004 - 2006	OEM Arm/Lock	WHITE	40	8	INSERT PIN *	(-)	BCM Right Side Of Fuse Box
				OEM Disarm/Unlcok	WHITE	40	7	INSERT PIN *	(-)	BCM Right Side Of Fuse Box
				Parking Lights	-	-	-	RED/BLUE	(+)	Drivers Kick Panel
				Horn Honk	GRAY	8	2	GREEN/WHITE	(-)	Horn Switch Top of Steering Column
				Clutch Bypass	BLUE	2	1	GREEN/RED	(-)	Clutch Switch
				Parking Brake	BLACK-	1	1	PINK/BLACK	(-)	Parking Brake Switch
Nissan	Micra	Std. Key Manual	2015 - 2019	OEM Arm/Lock	WHITE	40	8	GRAY	(-)	BCM Drivers Kick Panel
				OEM Disarm/Unlcok	WHITE	40	7	WHITE	(-)	BCM Drivers Kick Panel
				Parking Lights	GRAY	16	4	RED	(+)	Drivers Kick Panel
				Horn Honk	GRAY	8	5	RED	(-)	Horn Switch Top of Steering Column
				Clutch Bypass	BROWN	2	2	LT. GREEN	(+)	Clutch Switch
				Parking Brake	BLACK	1	1	LT. BLUE	(-)	Parking Brake Switch
Nissan	Sentra	Std. Key Manual (w/ alarm)	2007 - 2012	OEM Arm/Lock	-	-	-	BROWN	(-)	Drivers Kick Harness From Door
				OEM Disarm/Unlock	-	-	-	WHITE	(-)	Drivers Kick Harness From Door
				Parking Lights	GRAY	16	4	RED	(+)	Right Side Of Fuse Box
				Horn Honk	GRAY	8	3	GREEN	(-)	Horn Switch Top of Steering Column
				Clutch Bypass	BROWN	2	1	BROWN/RED	(+)	Clutch Switch
				Parking Brake	-	-	-	GREEN	(-)	Passenger Kick Panel Harness Going to Rear of Vehicle

\* See diagram on page 4 for Insert Pin instructions.

## Wire Location Chart Diagram #5

Make	Model	Trim	Year	Item	Connector Color	Connector Pins	Pin #	Wire Color	Polarity	Location
Nissan	Sentra	Std. Key Manual	2013 - 2019	OEM Arm/Lock	-	-	-	VIOLET	(-)	Drivers Kick Harness From Door
				OEM Disarm/Unlcok	-	-	-	BLUE	(-)	Drivers Kick Harness From Door
				Parking Lights	GRAY	16	4	RED	(+)	Right Side Of Fuse Box
				Horn Honk	GRAY	8	3	GREEN	(-)	Horn Switch Top of Steering Column
				Clutch Bypass	BROWN	2	1	BROWN/RED	(+)	Clutch Switch
				Parking Brake	-	-	-	GREEN	(-)	Parking Brake Switch Or Passenger Kick
Nissan	Versa	Std. Key Manual (w/ alarm)	2013 - 2019	OEM Arm/Lock	-	-	-	GRAY	(-)	Drivers Kick Harness From Door
				OEM Disarm/Unlcok	-	-	-	WHITE	(-)	Drivers Kick Harness From Door
				Parking Lights	GRAY	16	4	RED	(+)	Drivers Kick Panel
				Horn Honk	GRAY	8	5	RED	(-)	Horn Switch Top of Steering Column
				Clutch Bypass	BROWN	2	2	LT. GREEN	(+)	Clutch Switch
				Parking Brake	BLACK	1	1	LT. BLUE	(-)	Parking Brake Switch
Nissan	Versa Note	Std. Key Manual	2014 - 2018	OEM Arm/Lock	-	-	-	GRAY	(-)	Drivers Kick Harness From Door
				OEM Disarm/Unlcok	-	-	-	WHITE	(-)	Drivers Kick Harness From Door
				Parking Lights	WHITE	24	3	RED	(+)	Drivers Kick Panel
				Horn Honk	YELLOW	8	5	RED	(-)	Horn Switch Top of Steering Column
				Clutch Bypass	BROWN	2	2	LT. GREEN	(+)	Clutch Switch
				Parking Brake	BLACK	1	1	LT. BLUE	(-)	Parking Brake Switch
Nissan	Xterra	Std. Key Manual (w/ alarm)	2005 - 2015	OEM Arm/Lock	-	-	-	LT. BLUE	(-)	Drivers Kick Panel
				OEM Disarm/Unlcok	-	-	-	GRAY	(-)	Drivers Kick Panel
				Parking Lights	GRAY	8	1	GRAY	(+)	Drivers Kick Panel
				Horn Honk	WHITE	16	9	BROWN	(-)	Drivers Kick Panel
				Clutch Bypass	BLUE	2	2	RED or BLUE	(+)	Clutch Switch
				Parking Brake	-	-	-	GREEN	(-)	Parking Brake Switch
Suzuki	Equator	Std. Key Manual (w/ alarm)	2009 - 2011	OEM Arm/Lock	-	-	-	LT. BLUE	(-)	Drivers Kick Panel
				OEM Disarm/Unlcok	-	-	-	GRAY	(-)	Drivers Kick Panel
				Parking Lights	GRAY	8	1	GRAY	(+)	Drivers Kick Panel
				Horn Honk	WHITE	16	9	BROWN	(-)	Drivers Kick Panel
				Clutch Bypass	BLUE	2	2	RED or BLUE	(+)	Clutch Switch
				Parking Brake	-	-	-	GREEN	(-)	Parking Brake Switch

\* See diagram on page 4 for Insert Pin instructions.

## RS-X70 Diagram #5

**INSTALLER Feature #8 MUST be programmed to Double Unlock (Option #3).**  
See RS-X70 Installation Guide for programming procedure.

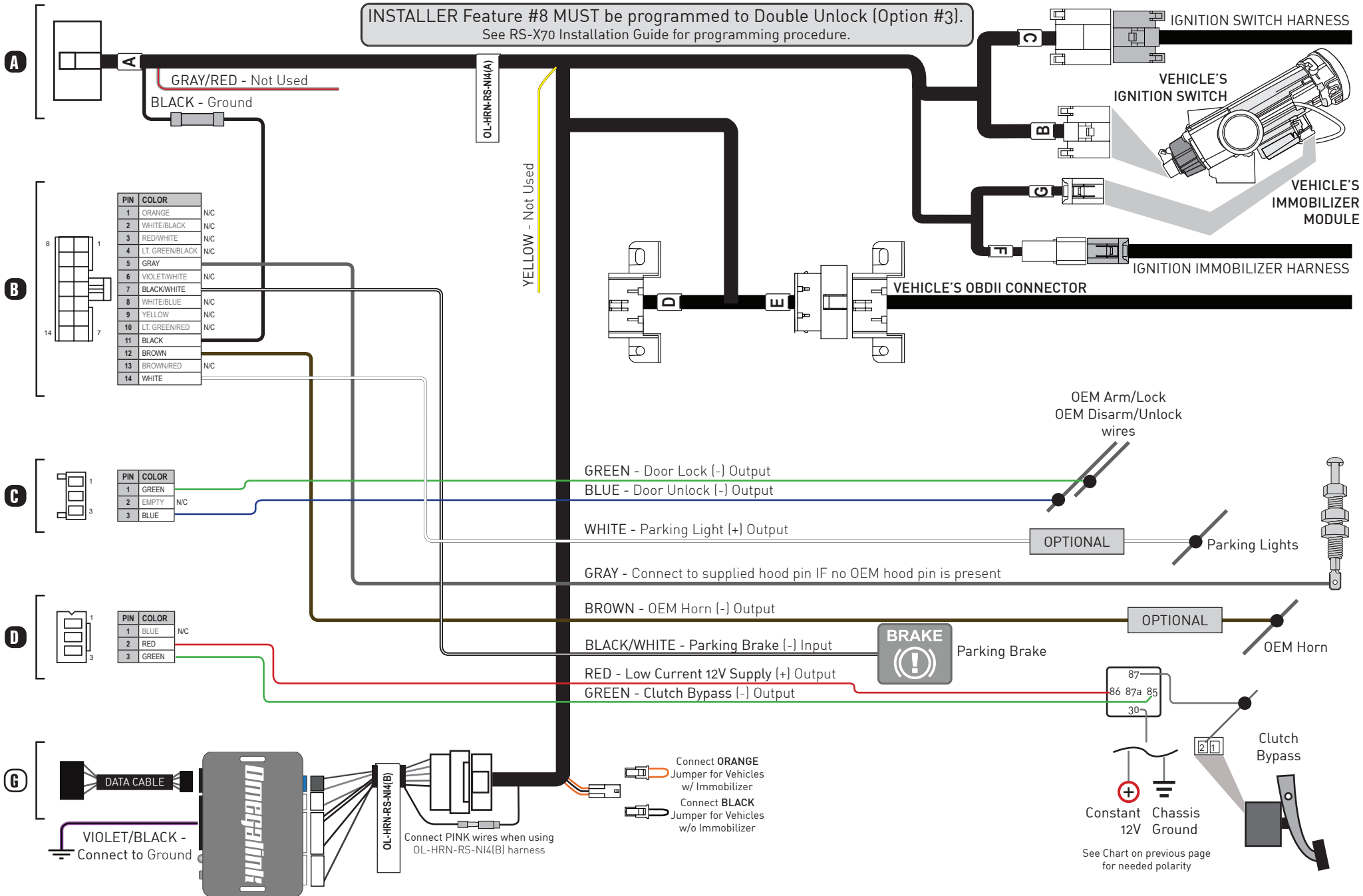

**Wire Location Chart Diagram #6**

Make	Model	Trim	Year	Item	Connector Color	Connector Pins	Pin #	Wire Color	Polarity	Location
Nissan	Versa	W/ Intelli-Key Manual	2007 - 2011	Intelli-Key Ignition	WHITE	40	6	YELLOW	(+)	Intelli-Key Module Behind Glove Box
				Keysense	GRAY	6	1	LT. GREEN	(+)	Ignition Switch
				Parking Lights	GRAY	16	4	RED	(+)	Drivers Kick Panel
				Horn Honk	GRAY	8	5	RED	(-)	Horn Switch Top of Steering Column
				Clutch Bypass	BROWN	2	2	LT. GREEN	(+)	Clutch Switch
				Parking Brake	BLACK	1	1	LT. BLUE	(-)	Parking Brake Switch

## MODEL: OL-HRN-RS-NI4

### RS-X70 Diagram #6

**INSTALLER Feature #6 MUST be programmed to GWR/Status (Option #2).**  
See RS-X70 installation Guide for programming procedure.

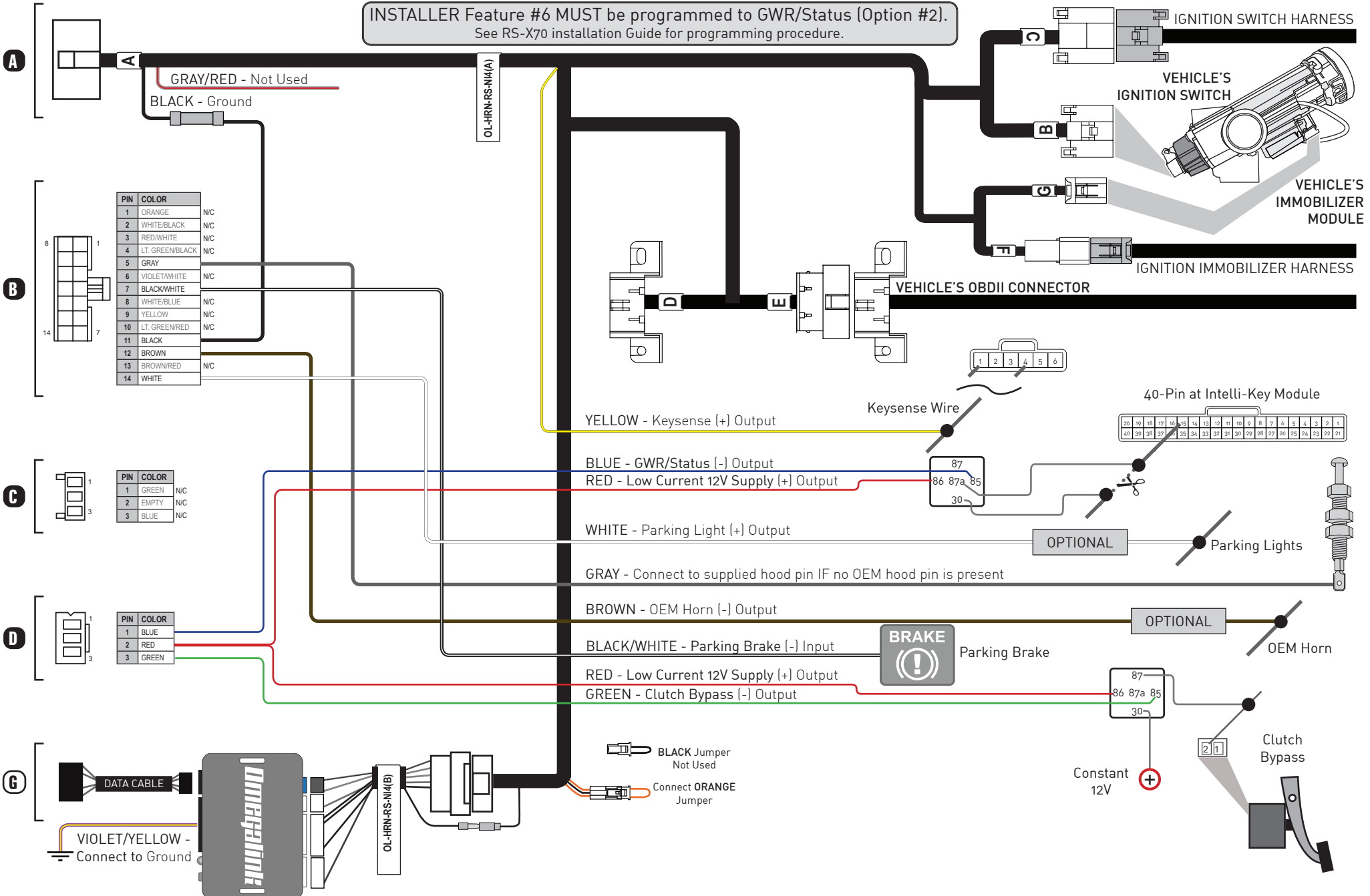

**RS-X70 Optional Accessories**

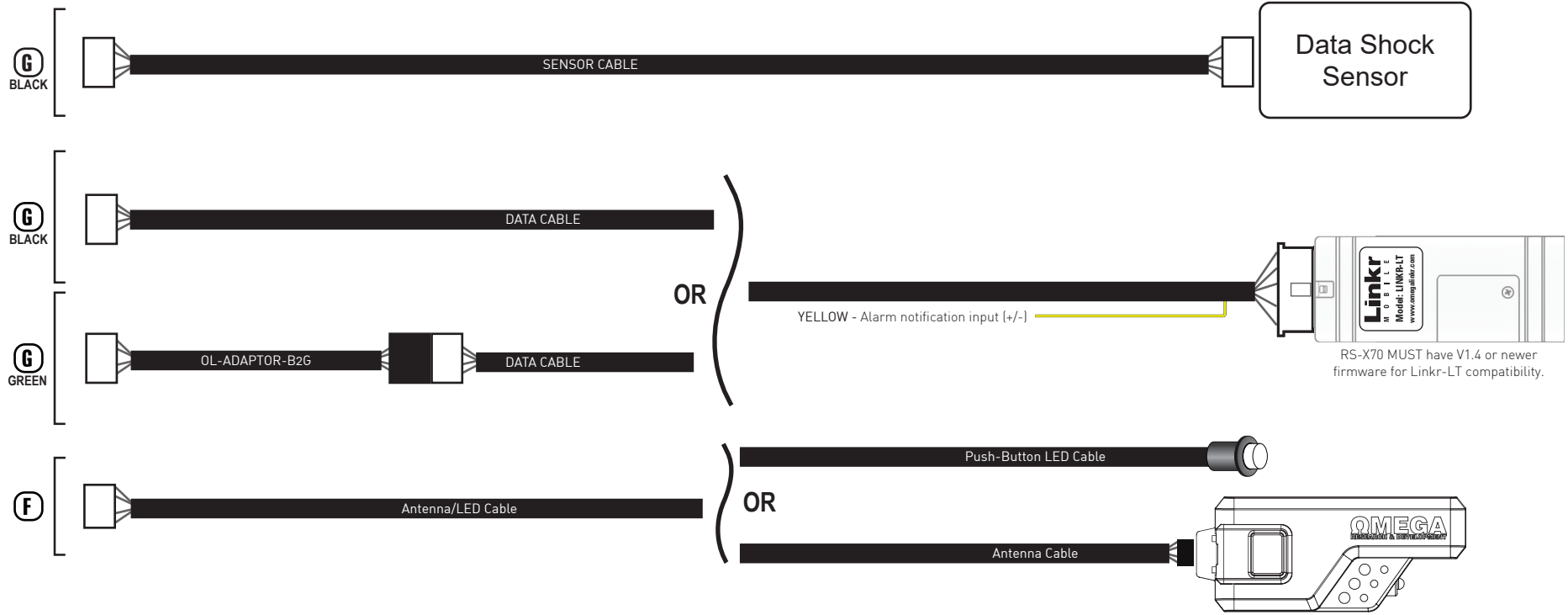

## Installation Mode Selection

1

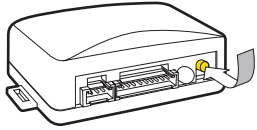

Press and release programming button to select installation mode.



LED flashes (1x) once = Data Mode (Recommended)  
LED flashes (2x) twice = Hardwire Mode

2

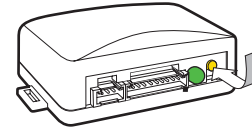

Press and hold programming button until LED turns solid GREEN to register selection.

**After registration, follow Factory Reset to change installation mode and restart this process.**

## Module Programming

### NOTES:

1. To complete this process you will need one regular key or one valet key.

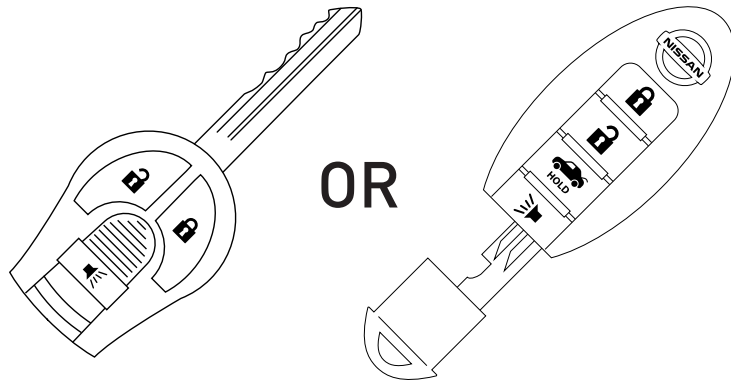

2. When programming, all key fobs must be located at least 10 feet away from the vehicle.

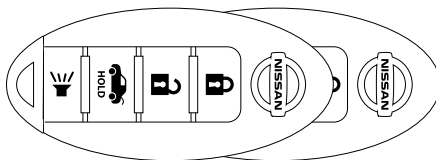

1

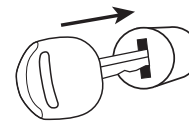

Insert the key into ignition.

2

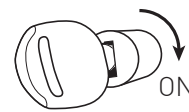

Turn the key to ON position.

3

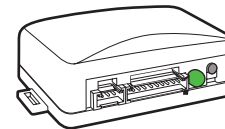

Wait, the LED will turn solid GREEN for 2 seconds.

4



Turn key to OFF position.

5

Proceed to RS-X70 Programming/  
Vehicle Learn.

## RS-X70 Programming/Vehicle Learn V1.6 (see installation guide for older versions)

### Before You Begin:

- Make sure all wires/harnesses are connected.
- Program the bypass module to the vehicle per the instructions on the previous pages.
- Connect any additional accessories/modules to the data ports.
- **MANUAL TRANSMISSION VEHICLES ONLY:** Set the parking brake. The BLACK/WHITE wire must be connected to the parking brake wire.

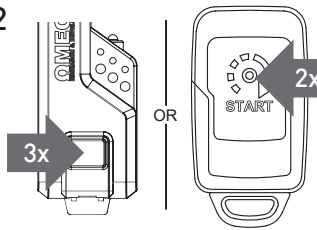
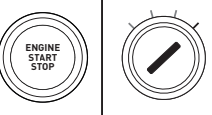
- 1** OFF ACC **ON** START  
Turn ignition to ON position (do not start).
- 
- 
- 2** Within 5 seconds of step 1 press the Valet button 3x or send remote start command (by remote, Linkr, activation input wire etc.).
- 
- The system will chirp & flash lights to indicate crank delay [Default: 1 chirp/flash = 1.5 sec]
  - Press valet button to change crank delay
  - Chirps: 1=1.5 sec, 2=15 sec, 3=20 sec, 4=30 sec
- 
- 3** OFF ACC ON **START**  
Start the engine with the key and let the engine reach normal idle.
- 
- 
- 4** OFF ACC ON START  
Release the parking brake.
- MANUAL TRANSMISSIONS:**
- AUTOMATIC TRANSMISSIONS:**  
Turn the ignition key OFF.
- The system will chirp & flash the lights equal the # of IGN/ACC/START circuits detected (Max: 4).
- MANUAL** - Proceed to step 5.  
**AUTOMATIC** - Skip to step 6.

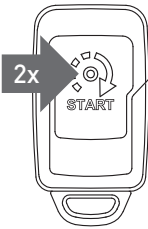
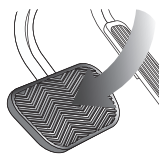
- 5** **BRAKE**  
**MANUAL TRANSMISSIONS:**  
Set the parking brake again to enter Manual Transmission Reservation Mode option selection. (installer feature #11)
- 
- The system will chirp & flash the light to indicate current setting (default: 2 - Off)
  - Set and Release the parking brake to scroll through setting options.
  - Chirp confirmation: 1 = **ON** - Shutdown w/ lock, 2 = **OFF**, 3 = **ON** - Shutdown w/ door close, 4 = **ON** - Shutdown 10 sec. after door close
  - Before turning the key OFF, perform the MT reservation sequence (see operation guide) and exit the vehicle.
- 
- 6** Activate remote start (within 60 sec. of Step 4 or 5). Wait until engine is running and LED flashes slowly (10-45 seconds after engine cranks & runs).  
**Push-to-Start vehicles:** Ensure the OEM fob is at least 20 ft. away to allow remote start.
- 
- The system will detect data protocols, select the best available engine running detection method, and, learn any available tach input (data or analog).
- 
- 7** **TO SAVE SETTINGS/FINISH VEHICLE LEARN:**  
Press the BRAKE pedal (will shut down RS).
- 
- This disables VEHICLE LEARN (to enable again, program installer feature #2 (bank 10) to "Enabled".
- TO CANCEL/START OVER:**  
Press the valet button once.
- 
- 8** Programming complete.

## Troubleshooting

- See system installation guide for remote start diagnostics and troubleshooting.
- See OmegaLink module/firmware guide at [www.wiresheet.com](http://www.wiresheet.com) for interface module diagnostics and troubleshooting.