



MODEL

OL-HRN-RS-GM10

GUIDE ID

CST_GM10_G6_G5_20210419

AVAILABLE ACCESSORIES

OL-HRN-RS-PWR

(Adapt to any brand remote start w/ BLADE or OL-MDB-ALL / FL-CAN / ADS-AL-CA)

VEHICLE COMPATIBILITY

For RSX-G5 installations see pages 4-20
(OL-HRN-RS-PWR-CST not included but required for G5 units)
For RSX-G6 installations see pages 21-38

Make	Model	Trim	Years	Firmware	Diagram
Buick	Enclave	Std. Key 6 Cyl. Automatic	2008 - 2017	DL-GM10	2
Buick	Lucerne	Std. Key Sedan 6/8 Cyl. Automatic	2006 - 2011	DL-GM10	3
Cadillac	CTS	Std. Key Coupe 6 Cyl. Automatic	2010 - 2011	DL-GM10	3
Cadillac	CTS	Std. Key Coupe 6 Cyl. Manual	2010 - 2013	DL-GM10	5
Cadillac	CTS	Std. Key Estate/Wagon 6 Cyl. Automatic	2009 - 2014	DL-GM10	3
Cadillac	CTS	Std. Key Estate/Wagon 6 Cyl. Manual	2009 - 2013	DL-GM10	5
Cadillac	CTS	Std. Key Sedan 6 Cyl. Automatic	2008 - 2013	DL-GM10	3
Cadillac	CTS	Std. Key Sedan 6 Cyl. Manual	2008 - 2013	DL-GM10	5
Cadillac	CTS-V	Std. Key Sedan 8 Cyl. Automatic	2009 - 2011	DL-GM10	3
Cadillac	CTS-V	Std. Key Sedan 8 Cyl. Manual	2009 - 2011	DL-GM10	5
Cadillac	DTS	Std. Key Sedan 8 Cyl. Automatic	2006 - 2011	DL-GM10	3
Cadillac	Escalade	Std. Key 8 Cyl. Automatic	2007 - 2014	DL-GM10	1

DISCLAIMER: The manufacturer of this product nor its affiliates accept any responsibility for any electrical damage to the vehicle or any other connected systems as a result of improper installation of this product. All wiring connections & vehicle compatibility must be verified by a professionally qualified technician prior to installation.

VEHICLE COMPATIBILITY (cont.)

Make	Model	Trim	Years	Firmware	Diagram
Cadillac	Escalade	Std. Key Hybrid Automatic	2009 - 2014	DL-GM10	1
Cadillac	Escalade ESV	Std. Key 8 Cyl. Automatic	2007 - 2014	DL-GM10	1
Cadillac	Escalade EXT	Std. Key 8 Cyl. Automatic	2007 - 2013	DL-GM10	1
Cadillac	SRX	Std. Key 6/8 Cyl. Automatic	2007 - 2009	DL-GM10	3
Chevrolet	Avalanche	Std. Key 8 Cyl. Automatic	2007 - 2013	DL-GM10	1
Chevrolet	Caprice	Std. Key Sedan 8 Cyl. Automatic	2011 - 2013	DL-GM10	2
Chevrolet	Captiva Sport	Std. Key 4/6 Cyl. Automatic	2008 - 2015	DL-GM10	3
Chevrolet	Captiva Sport	Std. Key Hybrid Automatic	2008 - 2012	DL-GM10	3
Chevrolet	Equinox	Std. Key 6 Cyl. Automatic	2007 - 2009	DL-GM10	3
Chevrolet	Express 1500	Std. Key 6/8 Cyl. Automatic	2008 - 2017	DL-GM10	1
Chevrolet	Express 2500	Std. Key 8 Cyl. Automatic	2008 - 2017	DL-GM10	1
Chevrolet	Express 2500	Std. Key Diesel Automatic	2010 - 2017	DL-GM10	1
Chevrolet	Express 3500	Std. Key 8 Cyl. Automatic	2008 - 2017	DL-GM10	1
Chevrolet	Express 3500	Std. Key Diesel Automatic	2010 - 2017	DL-GM10	1
Chevrolet	Impala	Std. Key Sedan 6/8 Cyl. Automatic	2006 - 2013	DL-GM10	3
Chevrolet	Impala Limited	Std. Key Sedan 6 Cyl. Automatic	2014 - 2016	DL-GM10	3
Chevrolet	Monte Carlo	Std. Key Coupe 6/8 Cyl. Automatic	2006 - 2007	DL-GM10	3
Chevrolet	Silverado 1500	Std. Key 6/8 Cyl. Automatic	2007 - 2013	DL-GM10	1
Chevrolet	Silverado 1500	Std. Key Hybrid Automatic	2010 - 2013	DL-GM10	1
Chevrolet	Silverado 1500	Std. Key w/ Premium Package 6/8 Cyl. Automatic	2007 - 2013	DL-GM10	1
Chevrolet	Silverado 2500	Std. Key 8 Cyl. Automatic	2007 - 2014	DL-GM10	1
Chevrolet	Silverado 2500	Std. Key Diesel Automatic	2007 - 2014	DL-GM10	1
Chevrolet	Silverado 3500	Std. Key 8 Cyl. Automatic	2007 - 2014	DL-GM10	1
Chevrolet	Silverado 3500	Std. Key Diesel Automatic	2007 - 2013	DL-GM10	1
Chevrolet	Suburban	Std. Key 8 Cyl. Automatic	2007 - 2014	DL-GM10	1
Chevrolet	Tahoe	Std. Key 8 Cyl. Automatic	2007 - 2014	DL-GM10	1
Chevrolet	Tahoe	Std. Key Hybrid Automatic	2007 - 2013	DL-GM10	1
Chevrolet	Traverse	Std. Key 6 Cyl. Automatic	2009 - 2017	DL-GM10	2
Chevrolet	Traverse	Std. Key w/ Auto Window Up/Down 6 Cyl. Automatic	2009 - 2017	DL-GM10	2
GMC	Acadia	Std. Key 6 Cyl. Automatic	2007 - 2016	DL-GM10	2

VEHICLE COMPATIBILITY (cont.)

Make	Model	Trim	Years	Firmware	Diagram
GMC	Acadia	Std. Key w/ Auto Window Up/Down 6 Cyl. Automatic	2007 - 2016	DL-GM10	2
GMC	Acadia Limited	Std. Key Automatic	2017 - 2017	DL-GM10	2
GMC	Savana 1500	Std. Key 6/8 Cyl. Automatic	2008 - 2017	DL-GM10	1
GMC	Savana 2500	Std. Key 8 Cyl. Automatic	2008 - 2017	DL-GM10	1
GMC	Savana 2500	Std. Key Diesel Automatic	2010 - 2017	DL-GM10	1
GMC	Savana 3500	Std. Key 8 Cyl. Automatic	2008 - 2017	DL-GM10	1
GMC	Savana 3500	Std. Key Diesel Automatic	2010 - 2017	DL-GM10	1
GMC	Sierra 1500	Std. Key 6/8 Cyl. Automatic	2007 - 2013	DL-GM10	1
GMC	Sierra 1500	Std. Key Hybrid Automatic	2007 - 2013	DL-GM10	1
GMC	Sierra 1500	Std. Key w/ Premium Package 6/8 Cyl. Automatic	2007 - 2013	DL-GM10	1
GMC	Sierra 2500	Std. Key 8 Cyl. Automatic	2007 - 2014	DL-GM10	1
GMC	Sierra 2500	Std. Key Diesel Automatic	2007 - 2014	DL-GM10	1
GMC	Sierra 3500	Std. Key 8 Cyl. Automatic	2007 - 2014	DL-GM10	1
GMC	Sierra 3500	Std. Key Diesel Automatic	2007 - 2014	DL-GM10	1
GMC	Yukon	Std. Key 8 Cyl. Automatic	2007 - 2014	DL-GM10	1
GMC	Yukon	Std. Key Hybrid Automatic	2007 - 2014	DL-GM10	1
Hummer	H2	Std. Key 8 Cyl. Automatic	2008 - 2009	DL-GM10	1
Pontiac	G8	Std. Key Sedan 6/8 Cyl. Automatic	2008 - 2009	DL-GM10	2
Pontiac	G8	Std. Key Sedan 6/8 Cyl. Manual	2008 - 2009	DL-GM10	4
Pontiac	Torrent	Std. Key 6 Cyl. Automatic	2007 - 2009	DL-GM10	3
Saturn	Outlook	Std. Key 6 Cyl. Automatic	2007 - 2010	DL-GM10	2
Saturn	Outlook	Std. Key w/ Auto Window Up/Down 6 Cyl. Automatic	2007 - 2010	DL-GM10	2
Saturn	VUE	Std. Key 4/6 Cyl. Automatic	2008 - 2010	DL-GM10	3
Saturn	VUE	Std. Key Hybrid Automatic	2008 - 2010	DL-GM10	3
Suzuki	XL-7	Std. Key 6 Cyl. Automatic	2007 - 2009	DL-GM10	3

RSX-G5 Layout

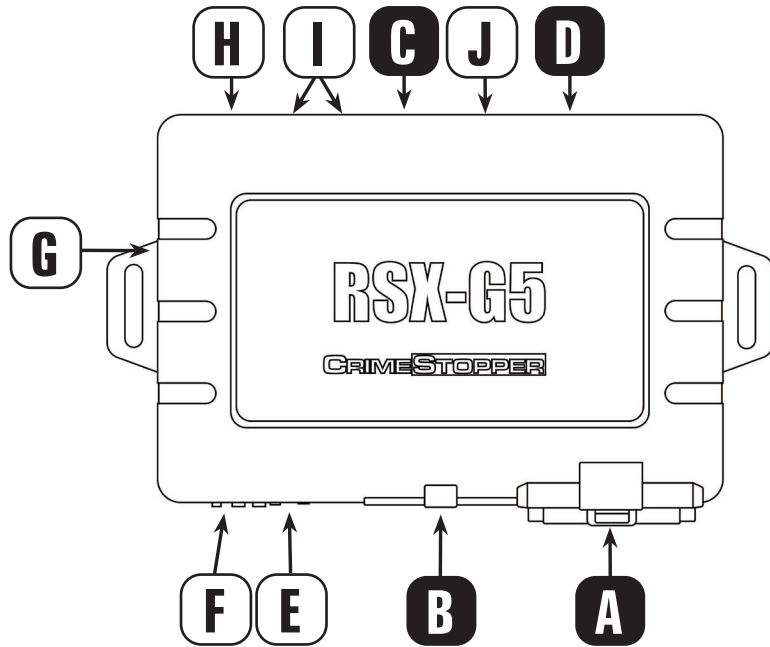

- A** BLACK 6 PIN HIGH CURRENT POWER HARNESS
NOTE: OL-HRN-RS-PWR-CST Adaptor Not Included With T-Harness & Will Be Required
- B** WHITE 12 PIN MAIN INPUT/OUTPUT HARNESS
- C** WHITE 3 PIN DOOR LOCK PORT
- D** RED 3 PIN LOW CURRENT AUX PORT
- E** BLUE 2 PIN PROGRAMMING/VALET PORT
- F** BLACK 3 PIN ANTENNA PORT
- G** SMART PHONE PORT - For LINKR-LT or TELE-CONNECT Smart Phone Interface modules
- H** NOT USED
- I** BLACK DATA PORTS - For Vehicle Interface Module.
(Fortin & iDataLink protocols supported on both ports - see feature #5)
- J** WHITE 2 PIN LED PORT

OL-HRN-RS-PWR-CST Required

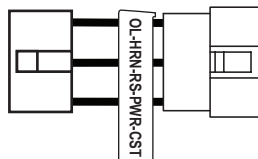

The OL-HRN-RS-PWR-CST re-configures the 6-pin (A) High Current Outputs to be compatible with the Excalibur T-Harness. This adaptor is required for proper operation. In some instances features #4 & #26 will need set to options other than default. In those situations there will be a note indicated the needed settings.

RSX-G5 Installation Steps

INSTALLATION STEPS:

- 1) Go to www.OmegaWeblink.com or use WebLink Mobile to flash the bypass module with the firmware matching the vehicle.
NOTE: iDataLink 2-way protocol is recommended for full functionality.
NOTE: If OEM remote is being used to activate the remote start be sure "Factory keyless RS sequence" is set to "Lock + Lock + Lock" OR "Lock + Unlock + Lock"
NOTE: For Manual Transmission vehicles Feature #11 MUST be set to the desired setting for proper operation.
- 2) Make all the connections shown in the diagram on the following pages.
- 3) Connect any optional hardware as needed.
- 4) Select Data Mode and program the bypass module to the vehicle (see module programming instructions).
- 5) Test the system for all desired functions.

NOTE: Any features NOT supported by the interface module must be hard wired from the remote start to the vehicle. Refer to the remote start install guide and vehicle wiring info at www.wiresheet.com (only available for authorized dealers) for instructions.

MODEL: OL-HRN-RS-GM10

Wire Location Chart Diagram #1

Make	Model	Trim	Year	Item	Connector Color	Connector Pins	Pin #	Wire Color	Polarity	Location
Cadillac	Escalade	8 Cyl. Automatic Hybrid Automatic	2007 - 2014	12 Volts	-	-	-	RED/BLACK	(+)	Drivers Fuse Box
				Parking Lights	-	-	-	LT. BLUE	(-)	Headlight Switch
				Horn	BROWN	25	18	TAN	(-)	BCM Center of Driver Dash Below Steering Column
				RAP Shutdown	Covered Via Data					
Cadillac	Escalade EXT/ Escalade ESV	8 Cyl. Automatic	2007 - 2014	12 Volts	-	-	-	RED/BLACK	(+)	Drivers Fuse Box
				Parking Lights	-	-	-	LT. BLUE	(-)	Headlight Switch
				Horn	BROWN	25	18	TAN	(-)	BCM Center of Driver Dash Below Steering Column
				RAP Shutdown	Covered Via Data					
Chevrolet	Avalanche	8 Cyl. Automatic	2007 - 2013	12 Volts	-	-	-	RED/BLACK	(+)	Drivers Fuse Box
				Parking Lights	-	-	-	LT. BLUE	(-)	Headlight Switch
				Horn	BROWN	25	18	TAN	(-)	BCM Center of Driver Dash Below Steering Column
				RAP Shutdown	Covered Via Data					
Chevrolet	Express 1500	6 Cyl. Automatic 8 Cyl. Automatic	2008 - 2017	12 Volts	-	-	-	RED/BLACK	(+)	Drivers Kick Panel
				Parking Lights	-	-	-	LT. BLUE	(-)	Headlight Switch
				Horn	-	-	-	TAN	(-)	Horn Switch
				RAP Shutdown	-	-	-	GRAY/BLACK	(-)	Drivers Kick Panel Harness From Door
Chevrolet	Express 2500/3500	8 Cyl. Automatic Diesel Automatic	2008 - 2017	12 Volts	-	-	-	RED/BLACK	(+)	Drivers Kick Panel
				Parking Lights	-	-	-	LT. BLUE	(-)	Headlight Switch
				Horn	-	-	-	TAN	(-)	Horn Switch
				RAP Shutdown	-	-	-	GRAY/BLACK	(-)	Drivers Kick Panel Harness From Door
Chevrolet	Silverado 1500	6 Cyl. Automatic 8 Cyl. Automatic	2007 - 2013	12 Volts	-	-	-	RED/BLACK	(+)	Drivers Fuse Box
				Parking Lights	-	-	-	LT. BLUE	(-)	Headlight Switch
				Horn	BROWN	25	18	TAN	(-)	BCM Center of Driver Dash Below Steering Column
				RAP Shutdown	Covered Via Data					
Chevrolet	Silverado 1500	Hybrid Automatic w/ Premium Package 6/8 Cyl. Automatic	2007 - 2013	12 Volts	-	-	-	RED/BLACK	(+)	Drivers Fuse Box
				Parking Lights	-	-	-	LT. BLUE	(-)	Headlight Switch
				Horn	BROWN	25	18	TAN	(-)	BCM Center of Driver Dash Below Steering Column
				RAP Shutdown	Covered Via Data					
Chevrolet	Silverado 2500/3500	8 Cyl. Automatic Diesel Automatic	2007 - 2014	12 Volts	-	-	-	RED/BLACK	(+)	Drivers Fuse Box
				Parking Lights	-	-	-	LT. BLUE	(-)	Headlight Switch
				Horn	BROWN	25	18	TAN	(-)	BCM Center of Driver Dash Below Steering Column
				RAP Shutdown	Covered Via Data					
Chevrolet	Suburban	8 Cyl. Automatic	2007 - 2014	12 Volts	-	-	-	RED/BLACK	(+)	Drivers Fuse Box
				Parking Lights	-	-	-	LT. BLUE	(-)	Headlight Switch
				Horn	BROWN	25	18	TAN	(-)	BCM Center of Driver Dash Below Steering Column
				RAP Shutdown	Covered Via Data					

MODEL: OL-HRN-RS-GM10

Wire Location Chart Diagram #1

Make	Model	Trim	Year	Item	Connector Color	Connector Pins	Pin #	Wire Color	Polarity	Location
Chevrolet	Tahoe	8 Cyl. Automatic Hybrid Automatic	2007 - 2014	12 Volts	-	-	-	RED/BLACK	(+)	Drivers Fuse Box
				Parking Lights	-	-	-	LT. BLUE	(-)	Headlight Switch
				Horn	BROWN	25	18	TAN	(-)	BCM Center of Driver Dash Below Steering Column
				RAP Shutdown	Covered Via Data					
GMC	Savana 1500	6 Cyl. Automatic 8 Cyl. Automatic	2008 - 2017	12 Volts	-	-	-	RED/BLACK	(+)	Drivers Kick Panel
				Parking Lights	-	-	-	LT. BLUE	(-)	Headlight Switch
				Horn	-	-	-	TAN	(-)	Horn Switch
				RAP Shutdown	-	-	-	GRAY/BLACK	(-)	Drivers Kick Panel Harness From Door
GMC	Savana 2500/3500	8 Cyl. Automatic Diesel Automatic	2008 - 2017	12 Volts	-	-	-	RED/BLACK	(+)	Drivers Kick Panel
				Parking Lights	-	-	-	LT. BLUE	(-)	Headlight Switch
				Horn	-	-	-	TAN	(-)	Horn Switch
				RAP Shutdown	-	-	-	GRAY/BLACK	(-)	Drivers Kick Panel Harness From Door
GMC	Sierra 1500	6 Cyl. Automatic 8 Cyl. Automatic	2007 - 2013	12 Volts	-	-	-	RED/BLACK	(+)	Drivers Fuse Box
				Parking Lights	-	-	-	LT. BLUE	(-)	Headlight Switch
				Horn	BROWN	25	18	TAN	(-)	BCM Center of Driver Dash Below Steering Column
				RAP Shutdown	Covered Via Data					
GMC	Sierra 1500	Hybrid Automatic w/ Premium Package 6/8 Cyl. Automatic	2007 - 2013	12 Volts	-	-	-	RED/BLACK	(+)	Drivers Fuse Box
				Parking Lights	-	-	-	LT. BLUE	(-)	Headlight Switch
				Horn	BROWN	25	18	TAN	(-)	BCM Center of Driver Dash Below Steering Column
				RAP Shutdown	Covered Via Data					
GMC	Sierra 2500/3500	8 Cyl. Automatic Diesel Automatic	2007 - 2014	12 Volts	-	-	-	RED/BLACK	(+)	Drivers Fuse Box
				Parking Lights	-	-	-	LT. BLUE	(-)	Headlight Switch
				Horn	BROWN	25	18	TAN	(-)	BCM Center of Driver Dash Below Steering Column
				RAP Shutdown	Covered Via Data					
GMC	Yukon	8 Cyl. Automatic Hybrid Automatic	2007 - 2014	12 Volts	-	-	-	RED/BLACK	(+)	Drivers Fuse Box
				Parking Lights	-	-	-	LT. BLUE	(-)	Headlight Switch
				Horn	BROWN	25	18	TAN	(-)	BCM Center of Driver Dash Below Steering Column
				RAP Shutdown	Covered Via Data					
Hummer	H2	8 Cyl. Automatic	2008 - 2009	12 Volts	-	-	-	RED/BLACK	(+)	Drivers Fuse Box
				Parking Lights	-	-	-	LT. BLUE	(-)	Headlight Switch
				Horn	BROWN	25	18	TAN	(-)	BCM Center of Driver Dash Below Steering Column
				RAP Shutdown	Covered Via Data					

MODEL: OL-HRN-RS-GM10

RSX-G5 Diagram #1

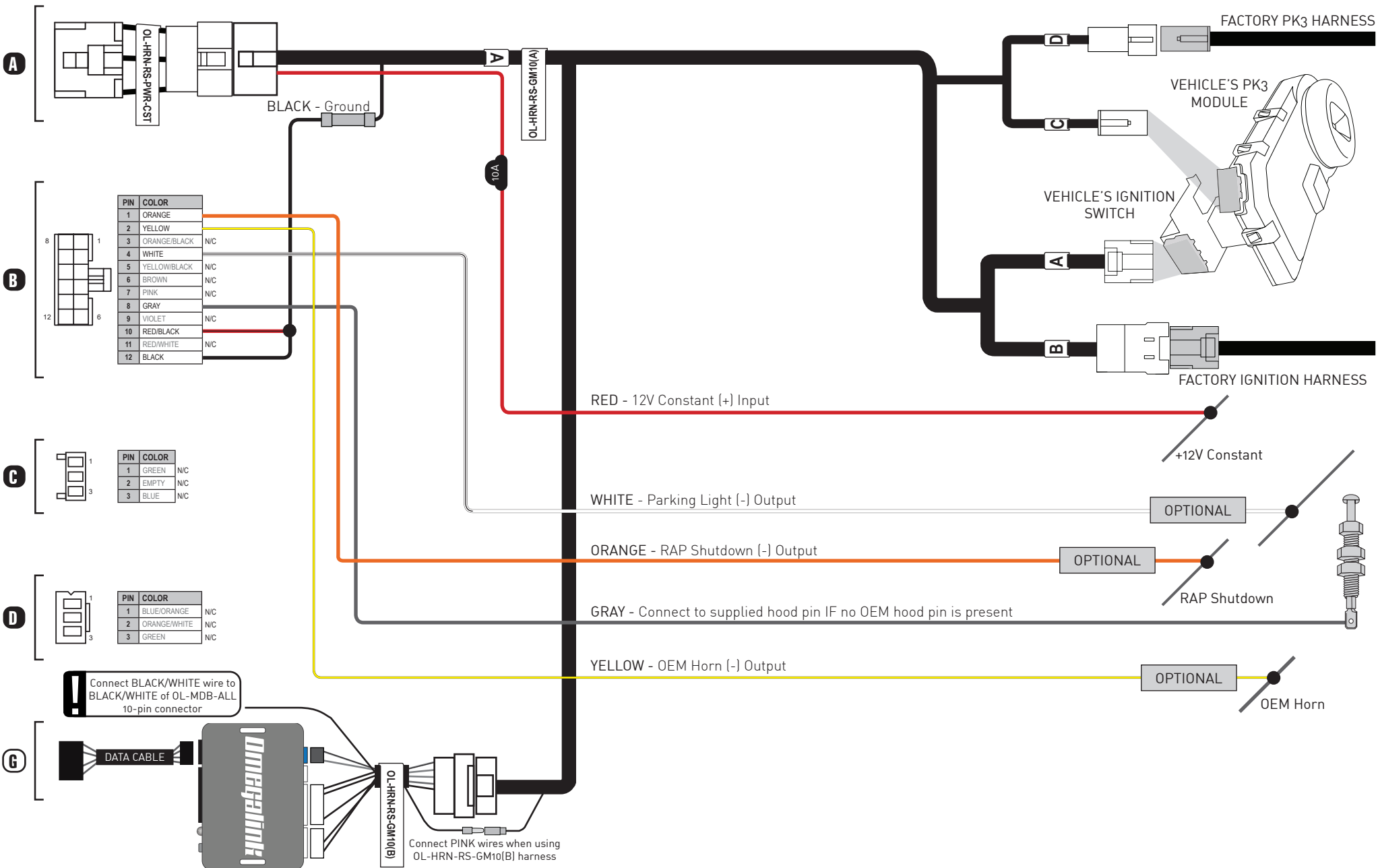

MODEL: OL-HRN-RS-GM10

Wire Location Chart Diagram #2

Make	Model	Trim	Year	Item	Connector Color	Connector Pins	Pin #	Wire Color	Polarity	Location
Buick	Enclave	6 Cyl. Automatic	2008 - 2017	12 Volts	BLACK	25	2	RED/WHITE	(+)	BCM Left Side Of Steering Column
				Parking Lights	WHITE	25	8	BROWN/WHITE	(-)	BCM Left Side Of Steering Column
				Horn	BROWN	25	18	TAN	(-)	BCM Left Side Of Steering Column
				RAP Shutdown	Covered Via Data					
Chevrolet	Caprice	Sedan 8 Cyl. Automatic	2011 - 2013	12 Volts	BLACK	25	1	RED/WHITE or ORANGE/RED	(+)	BCM Right Side Of Steering Column
				Parking Lights	WHITE	25	8	BROWN/WHITE	(-)	BCM Right Side Of Steering Column
				Horn	BROWN	25	18	BROWN/BLACK	(-)	BCM Right Side Of Steering Column
				RAP Shutdown	Covered Via Data					
Chevrolet	Traverse	6 Cyl. Automatic	2009 - 2017	12 Volts	BLACK	25	1	RED/WHITE	(+)	BCM Left Side Of Steering Column
				Parking Lights	WHITE	25	8	BROWN/WHITE	(-)	BCM Left Side Of Steering Column
				Horn	BROWN	25	18	TAN	(-)	BCM Left Side Of Steering Column
				RAP Shutdown	PINK	25	10	GRAY/BLACK	(-)	BCM Left Side Of Steering Column
Chevrolet	Traverse	w/ Auto Window Up/Down 6 Cyl. Automatic	2009 - 2017	12 Volts	BLACK	25	1	RED/WHITE	(+)	BCM Left Side Of Steering Column
				Parking Lights	WHITE	25	8	BROWN/WHITE	(-)	BCM Left Side Of Steering Column
				Horn	BROWN	25	18	TAN	(-)	BCM Left Side Of Steering Column
				RAP Shutdown	Covered Via Data					
GMC	Acadia	6 Cyl. Automatic	2007 - 2016	12 Volts	BLACK	25	1	RED/WHITE	(+)	BCM Left Side Of Steering Column
				Parking Lights	WHITE	25	8	BROWN/WHITE	(-)	BCM Left Side Of Steering Column
				Horn	BROWN	25	18	TAN	(-)	BCM Left Side Of Steering Column
				RAP Shutdown	PINK	25	10	GRAY/BLACK	(-)	BCM Left Side Of Steering Column
GMC	Acadia	w/ Auto Window Up/Down 6 Cyl. Automatic	2007 - 2016	12 Volts	BLACK	25	1	RED/WHITE	(+)	BCM Left Side Of Steering Column
				Parking Lights	WHITE	25	8	BROWN/WHITE	(-)	BCM Left Side Of Steering Column
				Horn	BROWN	25	18	TAN	(-)	BCM Left Side Of Steering Column
				RAP Shutdown	Covered Via Data					
GMC	Acadia Limited	Automatic	2017 - 2017	12 Volts	BLACK	25	1	RED/WHITE	(+)	BCM Left Side Of Steering Column
				Parking Lights	WHITE	25	8	BROWN/WHITE	(-)	BCM Left Side Of Steering Column
				Horn	BROWN	25	18	TAN	(-)	BCM Left Side Of Steering Column
				RAP Shutdown	Covered Via Data					
Pontiac	G8	Sedan 6 Cyl. Automatic Sedan 8 Cyl. Automatic	2008 - 2009	12 Volts	BLACK	25	1	RED/WHITE	(+)	BCM Right Side Of Steering Column
				Parking Lights	WHITE	25	8	BROWN/WHITE	(-)	BCM Right Side Of Steering Column
				Horn	BROWN	25	18	BROWN/BLACK	(-)	BCM Right Side Of Steering Column
				RAP Shutdown	PINK	25	10	GRAY/BLACK	(-)	BCM Right Side Of Steering Column

MODEL: OL-HRN-RS-GM10

Wire Location Chart Diagram #2

Make	Model	Trim	Year	Item	Connector Color	Connector Pins	Pin #	Wire Color	Polarity	Location
Saturn	Outlook	6 Cyl. Automatic	2007 - 2010	12 Volts	BLACK	25	1	RED/WHITE	(+)	BCM Left Side Of Steering Column
				Parking Lights	WHITE	25	8	BROWN/WHITE	(-)	BCM Left Side Of Steering Column
				Horn	BROWN	25	18	TAN	(-)	BCM Left Side Of Steering Column
				RAP Shutdown	PINK	25	10	GRAY/BLACK	(-)	BCM Left Side Of Steering Column
Saturn	Outlook	w/ Auto Window Up/Down 6 Cyl. Automatic	2007 - 2010	12 Volts	BLACK	25	1	RED/WHITE	(+)	BCM Left Side Of Steering Column
				Parking Lights	WHITE	25	8	BROWN/WHITE	(-)	BCM Left Side Of Steering Column
				Horn	BROWN	25	18	TAN	(-)	BCM Left Side Of Steering Column
				RAP Shutdown	Covered Via Data					

MODEL: OL-HRN-RS-GM10

RSX-G5 Diagram #2

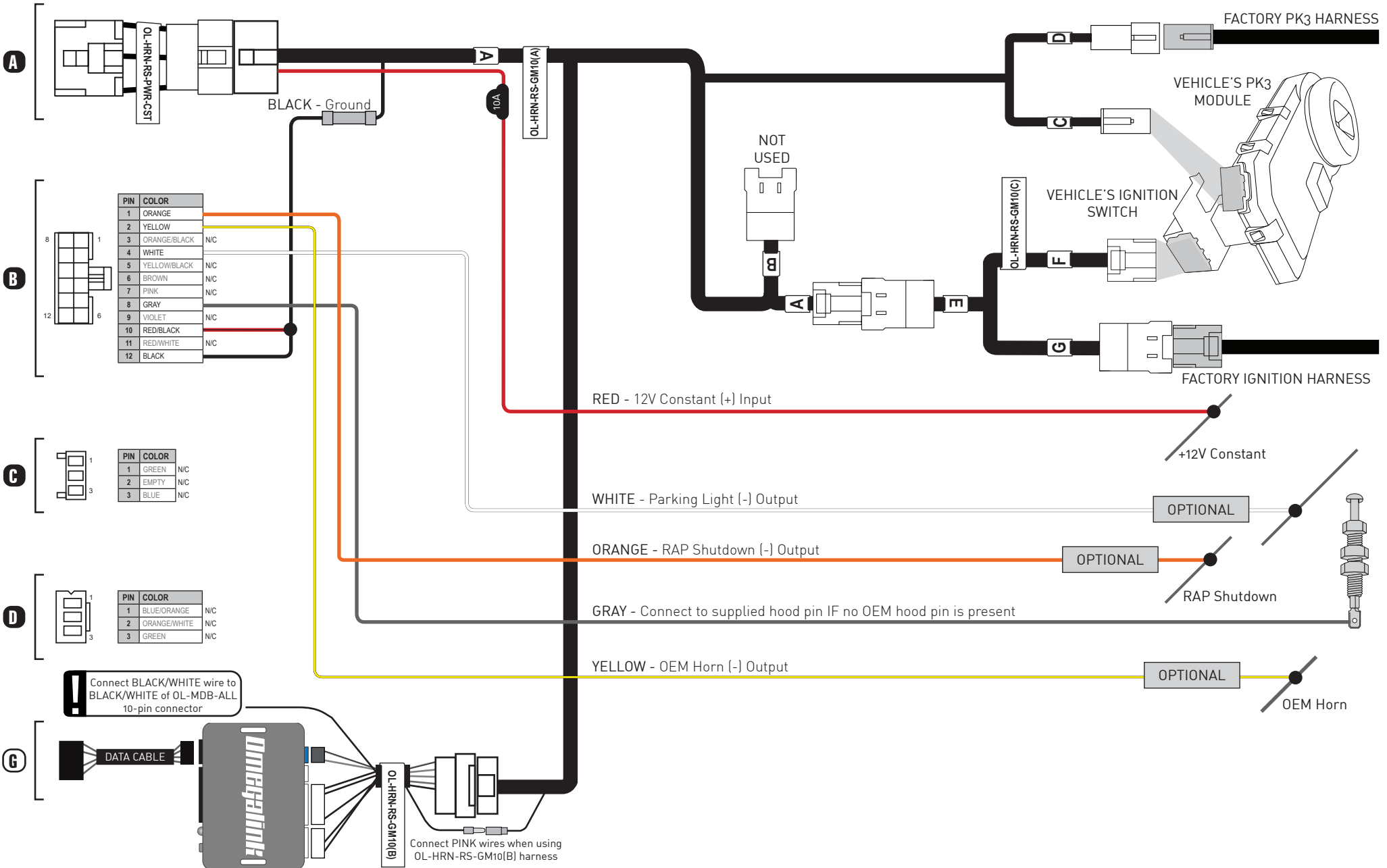

MODEL: OL-HRN-RS-GM10

Wire Location Chart Diagram #3

Make	Model	Trim	Year	Item	Connector Color	Connector Pins	Pin #	Wire Color	Polarity	Location
Buick	Lucerne	Sedan 6 Cyl. Automatic Sedan 8 Cyl. Automatic	2006 - 2011	12 Volts	BLACK	25	1	RED/YELLOW	(+)	BCM Passenger Side Dashboard
				Ignition	BLACK	6	1	PINK	(+)	Ignition Switch
				Passlock	BLACK	6	5	WHITE	MUX	Ignition Switch
				Parking Lights	WHITE	25	8	LT. BLUE/TAN	(-)	BCM Passenger Side Dashboard
				Horn	BROWN	25	18	TAN	(-)	BCM Passenger Side Dashboard
				RAP Shutdown	Covered Via Data					
Cadillac	CTS	Coupe 6 Cyl. Automatic	2010 - 2011	12 Volts	BLACK	25	2	RED/WHITE	(+)	BCM Passenger Side Dashboard
				Ignition	BLACK	6	1	PINK	(+)	Ignition Switch
				Passlock	BLACK	6	5	WHITE	MUX	Ignition Switch
				Parking Lights	WHITE	25	8	BROWN/WHITE	(-)	BCM Passenger Side Dashboard
				Horn	BROWN	25	18	BLACK	(-)	BCM Passenger Side Dashboard
				RAP Shutdown	Covered Via Data					
Cadillac	CTS	Estate/Wagon 6 Cyl. Automatic	2009 - 2014	12 Volts	BLACK	25	2	RED/WHITE	(+)	BCM Right Side Of Steering Column
				Ignition	BLACK	6	1	PINK	(+)	Ignition Switch
				Passlock	BLACK	6	5	WHITE	MUX	Ignition Switch
				Parking Lights	WHITE	25	8	BROWN/WHITE	(-)	BCM Right Side Of Steering Column
				Horn	BROWN	25	18	BLACK	(-)	BCM Right Side Of Steering Column
				RAP Shutdown	Covered Via Data					
Cadillac	CTS	Sedan 6 Cyl. Automatic	2008 - 2013	12 Volts	BLACK	25	2	RED/WHITE	(+)	BCM Right Side Of Steering Column
				Ignition	BLACK	6	1	PINK	(+)	Ignition Switch
				Passlock	BLACK	6	5	WHITE	MUX	Ignition Switch
				Parking Lights	WHITE	25	8	BROWN/WHITE	(-)	BCM Right Side Of Steering Column
				Horn	BROWN	25	18	BLACK	(-)	BCM Right Side Of Steering Column
				RAP Shutdown	Covered Via Data					
Cadillac	CTS-V	Sedan 8 Cyl. Automatic	2009 - 2011	12 Volts	BLACK	25	2	RED/WHITE	(+)	BCM Right Side Of Steering Column
				Ignition	BLACK	6	1	PINK	(+)	Ignition Switch
				Passlock	BLACK	6	5	WHITE	MUX	Ignition Switch
				Parking Lights	WHITE	25	8	BROWN/WHITE	(-)	BCM Right Side Of Steering Column
				Horn	BROWN	25	18	BLACK	(-)	BCM Right Side Of Steering Column
				RAP Shutdown	Covered Via Data					
Cadillac	DTS	Sedan 8 Cyl. Automatic	2006 - 2011	12 Volts	BLACK	25	1	RED/YELLOW	(+)	BCM Right Side Of Steering Column
				Ignition	BLACK	6	1	PINK	(+)	Ignition Switch
				Passlock	BLACK	6	5	WHITE	MUX	Ignition Switch
				Parking Lights	WHITE	25	8	LT. BLUE	(-)	BCM Right Side Of Steering Column
				Horn	BROWN	25	18	TAN	(-)	BCM Right Side Of Steering Column
				RAP Shutdown	Covered Via Data					

MODEL: OL-HRN-RS-GM10

Wire Location Chart Diagram #3

Make	Model	Trim	Year	Item	Connector Color	Connector Pins	Pin #	Wire Color	Polarity	Location
Cadillac	SRX	6 Cyl. Automatic 8 Cyl. Automatic	2007 - 2009	12 Volts	BLACK	25	2	RED/WHITE	(+)	BCM Left of Steering Column
				Ignition	BLACK	6	2	PINK	(+)	Ignition Switch
				Passlock	BLACK	6	5	WHITE	MUX	Ignition Switch
				Parking Lights	WHITE	25	8	BROWN/WHITE	(-)	BCM Left of Steering Column
				Horn	BROWN	-	18	TAN	(-)	BCM Left of Steering Column
				RAP Shutdown	Covered Via Data					
Chevrolet	Captiva Sport	4 Cyl. Automatic Hybrid Automatic	2008 - 2015	12 Volts	BLACK	25	1	RED/WHITE	(+)	BCM Below Radio
				Ignition	BLACK	6	1	PINK	(+)	Ignition Switch
				Passlock	BLACK	6	5	WHITE/BLACK	MUX	Ignition Switch
				Parking Lights	WHITE	25	8	LT. BLUE	(-)	BCM Below Radio
				Horn	BROWN	25	18	TAN	(-)	BCM Below Radio
				RAP Shutdown	Covered Via Data					
Chevrolet	Captiva Sport	6 Cyl. Automatic	2008 - 2015	12 Volts	BLACK	25	1	RED/WHITE	(+)	BCM Below Radio
				Ignition	BLACK	6	1	PINK	(+)	Ignition Switch
				Passlock	BLACK	6	5	WHITE/BLACK	MUX	Ignition Switch
				Parking Lights	WHITE	25	8	LT. BLUE	(-)	BCM Below Radio
				Horn	BROWN	25	18	TAN	(-)	BCM Below Radio
				RAP Shutdown	Covered Via Data					
Chevrolet	Equinox	6 Cyl. Automatic	2007 - 2009	12 Volts	BLACK	25	2	RED/WHITE	(+)	BCM Passenger Side Dashboard
				Ignition	BLACK	6	1	PINK	(+)	Ignition Switch
				Passlock	BLACK	6	5	WHITE	MUX	Ignition Switch
				Parking Lights	WHITE	25	8	BROWN/WHITE	(-)	BCM Passenger Side Dashboard
				Horn	BROWN	25	18	TAN	(-)	BCM Passenger Side Dashboard
				RAP Shutdown	PINK	25	10	GRAY/BLACK	(-)	BCM Passenger Side Dashboard
Chevrolet	Impala	Sedan 6 Cyl. Automatic Sedan 8 Cyl. Automatic	2006 - 2013	12 Volts	BLACK	25	2	RED/WHITE	(+)	BCM Left Side Of Steering Column
				Ignition	BLACK	6	1	PINK	(+)	Ignition Switch
				Passlock	BLACK	6	5	WHITE	MUX	Ignition Switch
				Parking Lights	WHITE	25	8	BROWN/WHITE	(-)	BCM Left Side Of Steering Column
				Horn	BROWN	25	18	TAN	(-)	BCM Left Side Of Steering Column
				RAP Shutdown	PINK	25	10	GRAY/BLACK	(-)	BCM Left Side Of Steering Column
Chevrolet	Impala Limited	Sedan 6 Cyl. Automatic	2014 - 2016	12 Volts	BLACK	25	2	RED/WHITE	(+)	BCM Left Side Of Steering Column
				Ignition	BLACK	6	1	PINK	(+)	Ignition Switch
				Passlock	BLACK	6	5	WHITE	(-)	Ignition Switch
				Parking Lights	WHITE	25	8	BROWN/WHITE	(-)	BCM Left Side Of Steering Column
				Horn	BROWN	25	18	TAN	(-)	BCM Left Side Of Steering Column
				RAP Shutdown	PINK	25	10	GRAY/BLACK	(-)	BCM Left Side Of Steering Column

MODEL: OL-HRN-RS-GM10

Wire Location Chart Diagram #3

Make	Model	Trim	Year	Item	Connector Color	Connector Pins	Pin #	Wire Color	Polarity	Location
Chevrolet	Monte Carlo	Coupe 6 Cyl. Automatic Coupe 8 Cyl. Automatic	2006 - 2007	12 Volts	BLACK	25	2	RED/WHITE	(+)	BCM Left Side Of Steering Column
				Ignition	BLACK	6	1	PINK	(+)	Ignition Switch
				Passlock	BLACK	6	5	WHITE	(-)	Ignition Switch
				Parking Lights	WHITE	25	8	BROWN/WHITE	(-)	BCM Left Side Of Steering Column
				Horn	BROWN	25	18	TAN	(-)	BCM Left Side Of Steering Column
				RAP Shutdown	PINK	25	10	GRAY/BLACK	(-)	BCM Left Side Of Steering Column
Pontiac	Torrent	6 Cyl. Automatic	2007 - 2009	12 Volts	BLACK	25	2	RED/WHITE	(+)	BCM Left Side Of Steering Column
				Ignition	BLACK	6	1	PINK	(+)	Ignition Switch
				Passlock	BLACK	6	5	WHITE	MUX	Ignition Switch
				Parking Lights	WHITE	25	8	BROWN/WHITE	(-)	BCM Left Side Of Steering Column
				Horn	BROWN	25	18	TAN	(-)	BCM Left Side Of Steering Column
				RAP Shutdown	PINK	25	10	GRAY/BLACK	(-)	BCM Left Side Of Steering Column
Saturn	VUE	4 Cyl. Automatic Hybrid Automatic	2008 - 2010	12 Volts	BLACK	25	2	RED/WHITE	(+)	BCM Under Radio
				Ignition	BLACK	6	1	PINK	(+)	Ignition Switch
				Passlock	BLACK	6	5	WHITE	MUX	Ignition Switch
				Parking Lights	WHITE	25	8	BROWN/WHITE	(-)	BCM Under Radio
				Horn	BROWN	25	18	TAN	(-)	BCM Under Radio
				RAP Shutdown	PINK	25	10	GRAY/BLACK	(-)	BCM Under Radio
Saturn	VUE	6 Cyl. Automatic	2008 - 2010	12 Volts	BLACK	25	1	RED/WHITE	(+)	BCM Under Radio
				Ignition	BLACK	6	2	PINK	(+)	Ignition Switch
				Passlock	BLACK	6	4	WHITE/BLACK	MUX	Ignition Switch
				Parking Lights	WHITE	25	8	LT. BLUE	(-)	BCM Under Radio
				Horn	BROWN	25	18	TAN	(-)	BCM Under Radio
				RAP Shutdown	PINK	25	10	GRAY/BLACK	(-)	BCM Under Radio
Suzuki	XL-7	6 Cyl. Automatic	2007 - 2009	12 Volts	BLACK	25	2	RED/WHITE	(+)	BCM Under Radio
				Ignition	BLACK	6	1	PINK	(+)	Ignition Switch
				Passlock	BLACK	6	5	WHITE	(-)	Ignition Switch
				Parking Lights	WHITE	25	8	BROWN/WHITE	(-)	BCM Under Radio
				Horn	BROWN	25	18	TAN	(-)	BCM Under Radio
				RAP Shutdown	PINK	25	10	GRAY/BLACK	(-)	BCM Under Radio

RSX-G5 Diagram #3

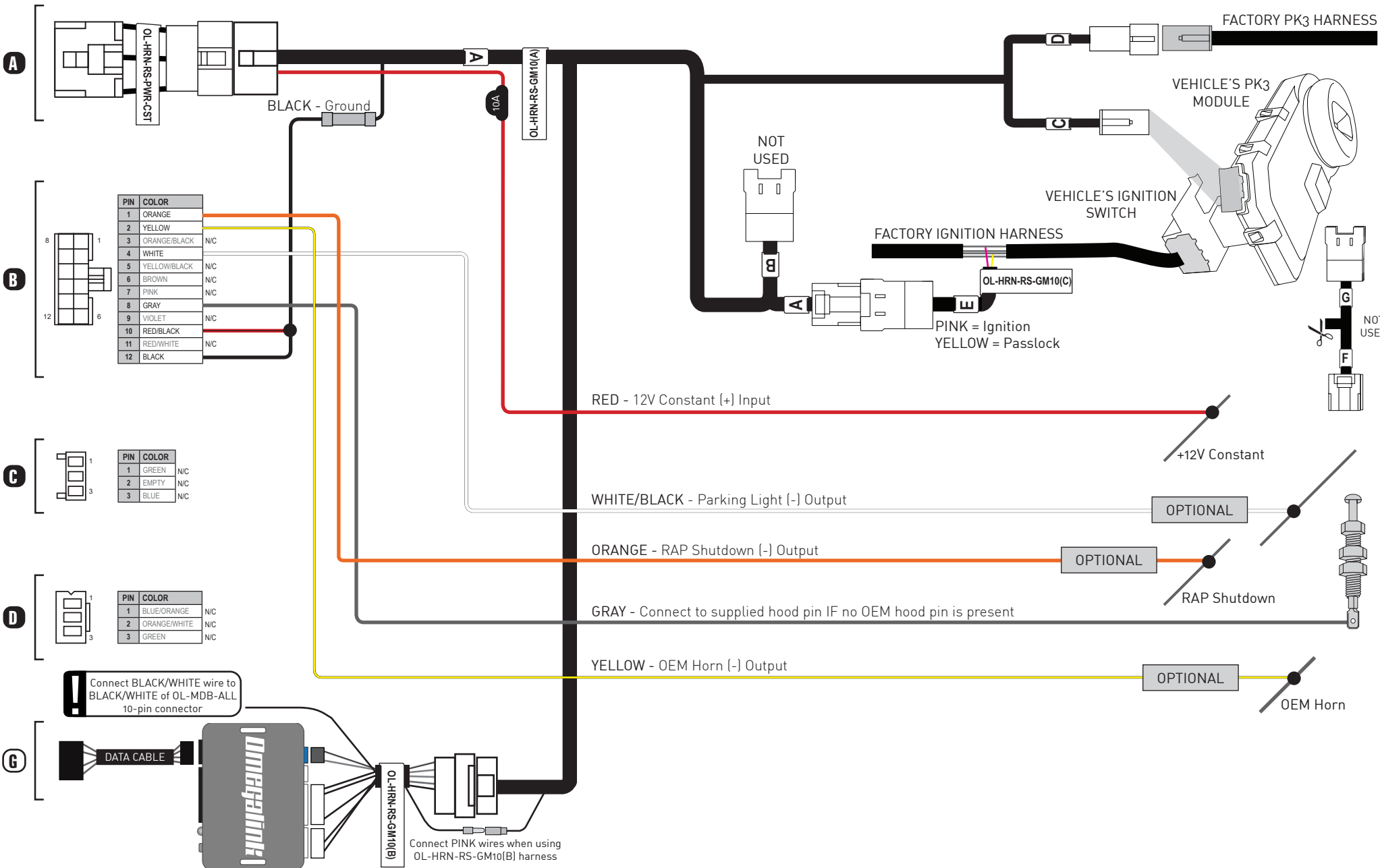

Wire Location Chart Diagram #4

Make	Model	Trim	Year	Item	Connector Color	Connector Pins	Pin #	Wire Color	Polarity	Location
Pontiac	G8	Sedan 6 Cyl. Manual Sedan 8 Cyl. Manual	2008 - 2009	12 Volts	BLACK	25	1	RED/WHITE or ORANGE/RED	(+)	BCM Right Side Of Steering Column
				Parking Lights	WHITE	25	8	BROWN/WHITE	(-)	BCM Right Side Of Steering Column
				Horn	BROWN	25	18	BROWN/BLACK	(-)	BCM Right Side Of Steering Column
				RAP Shutdown	PINK	25	10	GRAY/BLACK	(-)	BCM Right Side Of Steering Column
				Parking Brake	BROWN	25	16	ORANGE/BLACK	(-)	BCM Right Side Of Steering Column
				Clutch Bypass	BLACK	3	B	YELLOW	MUX	Clutch Switch

RSX-G5 Diagram #4

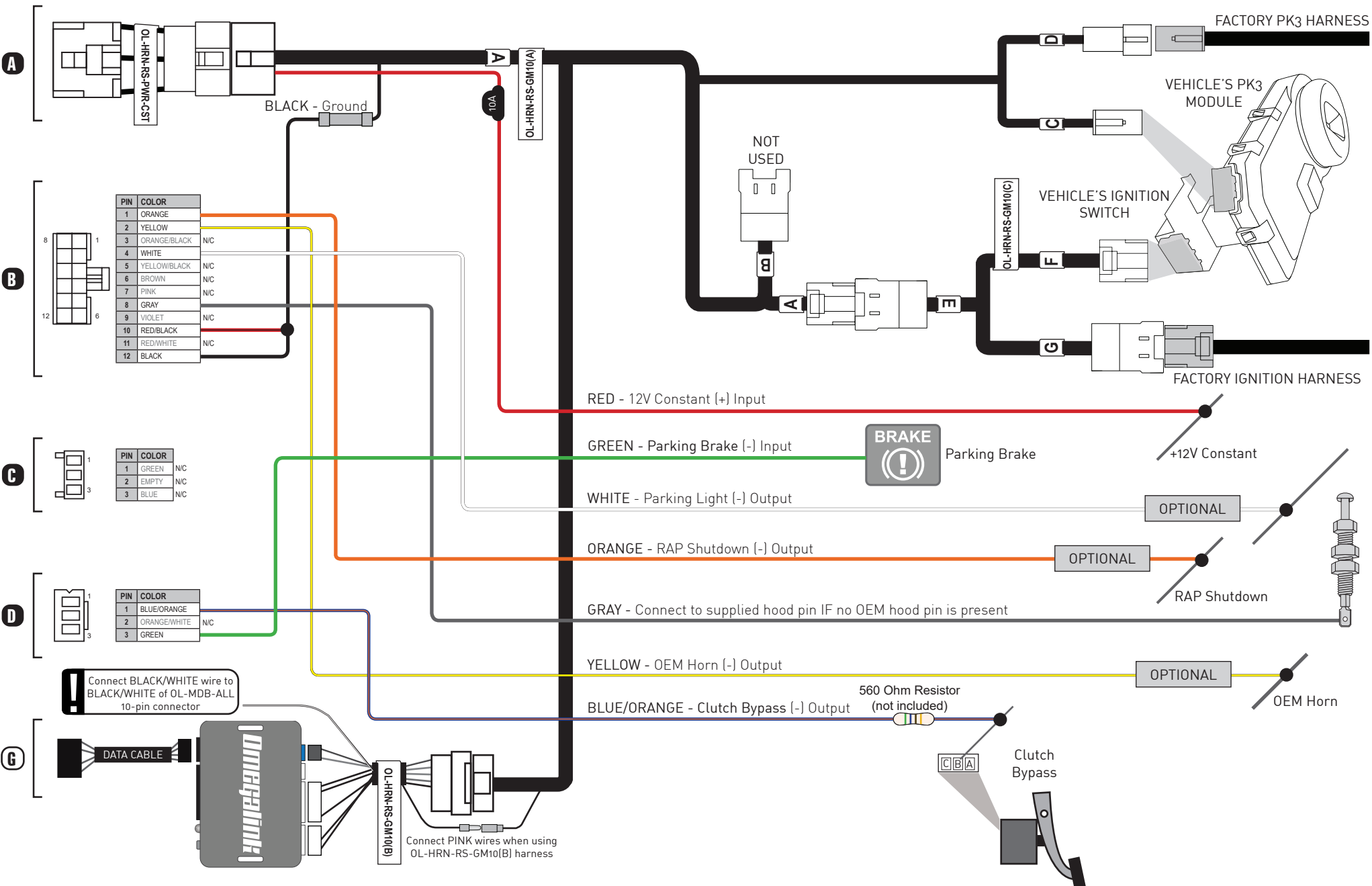

MODEL: OL-HRN-RS-GM10

Wire Location Chart Diagram #5

Make	Model	Trim	Year	Item	Connector Color	Connector Pins	Pin #	Wire Color	Polarity	Location			
Cadillac	CTS	Coupe 6 Cyl. Manual	2010 - 2013	12 Volts	BLACK	25	2	RED/WHITE	(+)	BCM Right Of Steering Column			
				Ignition	BLACK	6	1	PINK	(+)	Ignition Switch			
				Passlock	BLACK	6	5	WHITE	MUX	Ignition Switch			
				Parking Lights	WHITE	25	8	BROWN/WHITE	(-)	BCM Right Of Steering Column			
				Horn	BROWN	25	18	BLACK	(-)	BCM Right Of Steering Column			
				RAP Shutdown	Covered Via Data								
				Parking Brake	BROWN	25	16	ORANGE/BLACK	(-)	BCM Right Of Steering Column			
				Clutch Bypass	BLACK	3	B	TAN or LT. GREEN	MUX	Clutch Switch			
Cadillac	CTS	Estate/Wagon 6 Cyl. Manual	2009 - 2013	12 Volts	BLACK	25	2	RED/WHITE	(+)	BCM Right Of Steering Column			
				Ignition	BLACK	6	1	PINK	(+)	Ignition Switch			
				Passlock	BLACK	6	5	WHITE	MUX	Ignition Switch			
				Parking Lights	WHITE	25	8	BROWN/WHITE	(-)	BCM Right Of Steering Column			
				Horn	BROWN	25	18	BLACK	(-)	BCM Right Of Steering Column			
				RAP Shutdown	Covered Via Data								
				Parking Brake	BROWN	25	16	ORANGE/BLACK	(-)	BCM Right Of Steering Column			
				Clutch Bypass	BLACK	3	B	TAN or LT. GREEN	MUX	Clutch Switch			
Cadillac	CTS	Sedan 6 Cyl. Manual	2008 - 2013	12 Volts	BLACK	25	2	RED/WHITE	(+)	BCM Right Of Steering Column			
				Ignition	BLACK	6	1	PINK	(+)	Ignition Switch			
				Passlock	BLACK	6	5	WHITE	MUX	Ignition Switch			
				Parking Lights	WHITE	25	8	BROWN/WHITE	(-)	BCM Right Of Steering Column			
				Horn	BROWN	25	18	BLACK	(-)	BCM Right Of Steering Column			
				RAP Shutdown	Covered Via Data								
				Parking Brake	BROWN	25	16	ORANGE/BLACK	(-)	BCM Right Of Steering Column			
				Clutch Bypass	BLACK	3	B	TAN or LT. GREEN	MUX	Clutch Switch			
Cadillac	CTS-V	Sedan 8 Cyl. Manual	2009 - 2011	12 Volts	BLACK	25	2	RED/WHITE	(+)	BCM Right Of Steering Column			
				Ignition	BLACK	6	1	PINK	(+)	Ignition Switch			
				Passlock	BLACK	6	5	WHITE	MUX	Ignition Switch			
				Parking Lights	WHITE	25	8	BROWN/WHITE	(-)	BCM Right Of Steering Column			
				Horn	BROWN	25	18	BLACK	(-)	BCM Right Of Steering Column			
				RAP Shutdown	Covered Via Data								
				Parking Brake	BROWN	25	16	ORANGE/BLACK	(-)	BCM Right Of Steering Column			
				Clutch Bypass	BLACK	3	B	TAN or LT. GREEN	MUX	Clutch Switch			

MODEL: OL-HRN-RS-GM10

RSX-G5 Diagram #5

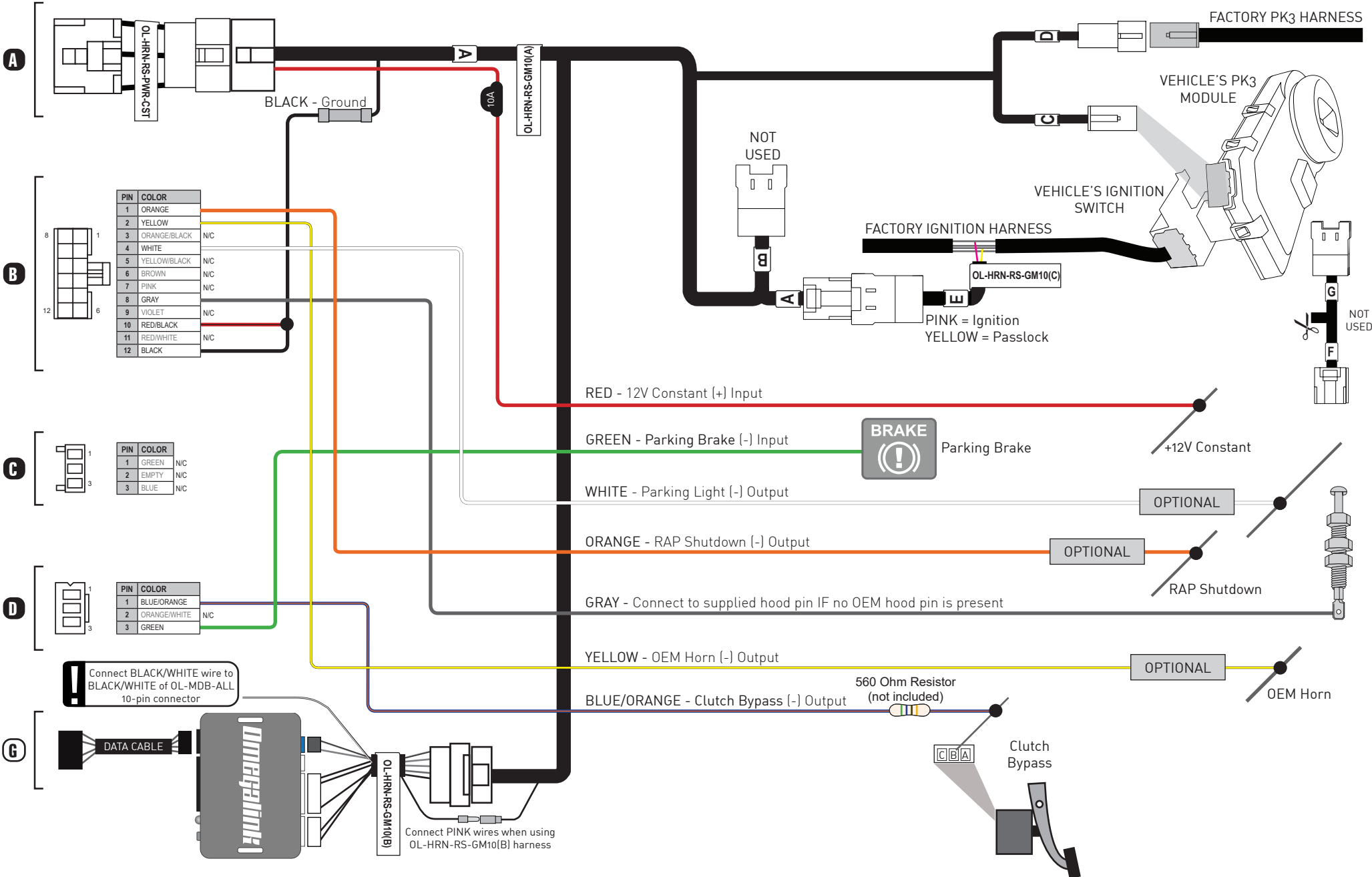

MODEL: OL-HRN-RS-GM10

GUIDE ID: CGT_GM10_G6_G5_20210419

RSX-G5 Optional Accessories

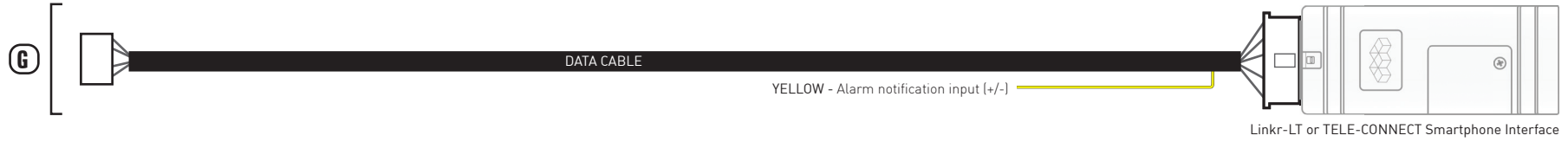

Installation Mode Selection

- 1 Press and release programming button to select installation mode.

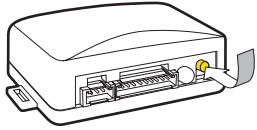

- LED flashes (1x) once = Data Mode (Recommended)
- LED flashes (2x) twice = Hardwire Mode

- 2 Press and hold programming button until LED turns solid GREEN to register selection.

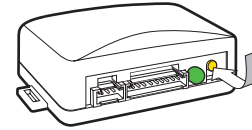

After registration, follow Factory Reset to change installation mode and restart this process.

Module Programming

- 1 Close driver door.
Re-open driver door to wake up data bus

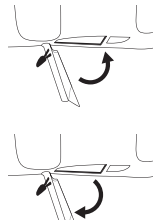

- 2 Insert the key into the ignition.

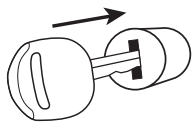

- 3 Turn the key to the ON position.

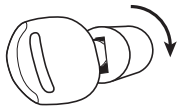

- 4 Wait, LED will turn solid GREEN for 2 seconds. (This could take up to 1 minute)

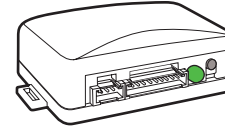

- 5 Turn the key to the OFF position.

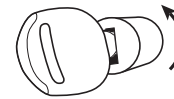

- 6 Programming complete. Verify all Remote Start settings and test.

RSX-G6 Layout

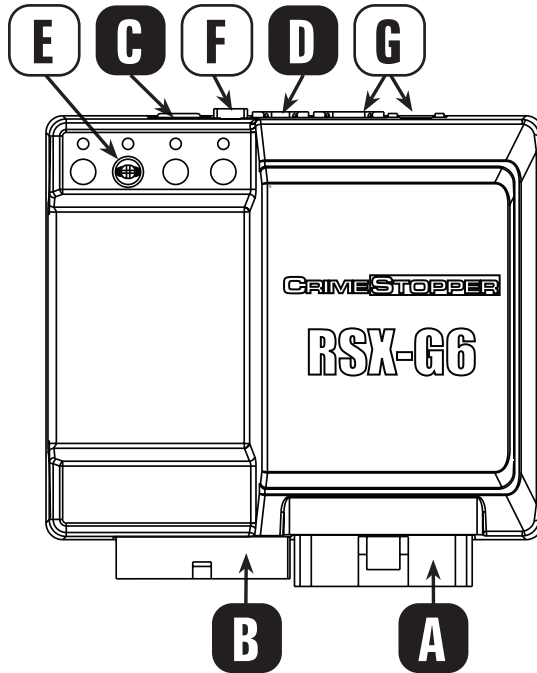

- A** WHITE 6 PIN HIGH CURRENT POWER HARNESS (P/N: H-RS6F*)
- B** WHITE 14 PIN MAIN INPUT/OUTPUT HARNESS (P/N: H-RS14F)
- C** RED 3 PIN DOOR LOCK/UNLOCK HARNESS (P/N: DLP-N3)
- D** RED 3 PIN REMOTE START HARNESS (P/N: H-RS3A)
- E** TEMPERATURE SENSOR - **DO NOT COVER**
(For high/low temp auto start and for automatic low temp crank extender)
- F** ANTENNA / STATUS LIGHT / VALET PORT - Supports compatible plug-in antennas or push-button status light
(P/N: AU-LED-PB2)
- G** GREEN & BLACK DATA PORTS - For Telematics / Data Sensor (Shock, Tilt, etc) / Vehicle Interface Module.
(DBI & iDataLink protocols supported on both ports - see 'Vehicle Learn' or installer feature #12)

RSX-G6 Installation Steps

INSTALLATION STEPS:

- 1) Go to www.OmegaWeblink.com or use WebLink Mobile to flash the bypass module with the firmware matching the vehicle.
NOTE: iDataLink 2-way protocol is recommended for full functionality.
NOTE: If OEM remote is being used to activate the remote start be sure "Factory keyless RS sequence" is set to "Lock + Lock + Lock" OR "Lock + Unlock + Lock"
- 2) Make all the connections shown in the diagram on the following pages.
- 3) Connect any optional hardware as needed.
- 4) Select Data Mode and program the bypass module to the vehicle (see module programming instructions).
- 5) Perform Vehicle Learn to configure the remote start to match the vehicle.
NOTE: If Vehicle Learn is not performed remote start operation could fail.
- 6) Test the system for all desired functions.

NOTE: Any features NOT supported by the interface module must be hard wired from the remote start to the vehicle. Refer to the remote start install guide and vehicle wiring info at www.wiresheet.com (only available for authorized dealers) for instructions.

MODEL: OL-HRN-RS-GM10

Wire Location Chart Diagram #1

Make	Model	Trim	Year	Item	Connector Color	Connector Pins	Pin #	Wire Color	Polarity	Location
Cadillac	Escalade	8 Cyl. Automatic Hybrid Automatic	2007 - 2014	12 Volts	-	-	-	RED/BLACK	(+)	Drivers Fuse Box
				Parking Lights	-	-	-	LT. BLUE	(-)	Headlight Switch
				Horn	BROWN	25	18	TAN	(-)	BCM Center of Driver Dash Below Steering Column
				RAP Shutdown	Covered Via Data					
Cadillac	Escalade EXT/ Escalade ESV	8 Cyl. Automatic	2007 - 2014	12 Volts	-	-	-	RED/BLACK	(+)	Drivers Fuse Box
				Parking Lights	-	-	-	LT. BLUE	(-)	Headlight Switch
				Horn	BROWN	25	18	TAN	(-)	BCM Center of Driver Dash Below Steering Column
				RAP Shutdown	Covered Via Data					
Chevrolet	Avalanche	8 Cyl. Automatic	2007 - 2013	12 Volts	-	-	-	RED/BLACK	(+)	Drivers Fuse Box
				Parking Lights	-	-	-	LT. BLUE	(-)	Headlight Switch
				Horn	BROWN	25	18	TAN	(-)	BCM Center of Driver Dash Below Steering Column
				RAP Shutdown	Covered Via Data					
Chevrolet	Express 1500	6 Cyl. Automatic 8 Cyl. Automatic	2008 - 2017	12 Volts	-	-	-	RED/BLACK	(+)	Drivers Kick Panel
				Parking Lights	-	-	-	LT. BLUE	(-)	Headlight Switch
				Horn	-	-	-	TAN	(-)	Horn Switch
				RAP Shutdown	-	-	-	GRAY/BLACK	(-)	Drivers Kick Panel Harness From Door
Chevrolet	Express 2500/3500	8 Cyl. Automatic Diesel Automatic	2008 - 2017	12 Volts	-	-	-	RED/BLACK	(+)	Drivers Kick Panel
				Parking Lights	-	-	-	LT. BLUE	(-)	Headlight Switch
				Horn	-	-	-	TAN	(-)	Horn Switch
				RAP Shutdown	-	-	-	GRAY/BLACK	(-)	Drivers Kick Panel Harness From Door
Chevrolet	Silverado 1500	6 Cyl. Automatic 8 Cyl. Automatic	2007 - 2013	12 Volts	-	-	-	RED/BLACK	(+)	Drivers Fuse Box
				Parking Lights	-	-	-	LT. BLUE	(-)	Headlight Switch
				Horn	BROWN	25	18	TAN	(-)	BCM Center of Driver Dash Below Steering Column
				RAP Shutdown	Covered Via Data					
Chevrolet	Silverado 1500	Hybrid Automatic w/ Premium Package 6/8 Cyl. Automatic	2007 - 2013	12 Volts	-	-	-	RED/BLACK	(+)	Drivers Fuse Box
				Parking Lights	-	-	-	LT. BLUE	(-)	Headlight Switch
				Horn	BROWN	25	18	TAN	(-)	BCM Center of Driver Dash Below Steering Column
				RAP Shutdown	Covered Via Data					
Chevrolet	Silverado 2500/3500	8 Cyl. Automatic Diesel Automatic	2007 - 2014	12 Volts	-	-	-	RED/BLACK	(+)	Drivers Fuse Box
				Parking Lights	-	-	-	LT. BLUE	(-)	Headlight Switch
				Horn	BROWN	25	18	TAN	(-)	BCM Center of Driver Dash Below Steering Column
				RAP Shutdown	Covered Via Data					
Chevrolet	Suburban	8 Cyl. Automatic	2007 - 2014	12 Volts	-	-	-	RED/BLACK	(+)	Drivers Fuse Box
				Parking Lights	-	-	-	LT. BLUE	(-)	Headlight Switch
				Horn	BROWN	25	18	TAN	(-)	BCM Center of Driver Dash Below Steering Column
				RAP Shutdown	Covered Via Data					

MODEL: OL-HRN-RS-GM10

Wire Location Chart Diagram #1

Make	Model	Trim	Year	Item	Connector Color	Connector Pins	Pin #	Wire Color	Polarity	Location
Chevrolet	Tahoe	8 Cyl. Automatic Hybrid Automatic	2007 - 2014	12 Volts	-	-	-	RED/BLACK	(+)	Drivers Fuse Box
				Parking Lights	-	-	-	LT. BLUE	(-)	Headlight Switch
				Horn	BROWN	25	18	TAN	(-)	BCM Center of Driver Dash Below Steering Column
				RAP Shutdown	Covered Via Data					
GMC	Savana 1500	6 Cyl. Automatic 8 Cyl. Automatic	2008 - 2017	12 Volts	-	-	-	RED/BLACK	(+)	Drivers Kick Panel
				Parking Lights	-	-	-	LT. BLUE	(-)	Headlight Switch
				Horn	-	-	-	TAN	(-)	Horn Switch
				RAP Shutdown	-	-	-	GRAY/BLACK	(-)	Drivers Kick Panel Harness From Door
GMC	Savana 2500/3500	8 Cyl. Automatic Diesel Automatic	2008 - 2017	12 Volts	-	-	-	RED/BLACK	(+)	Drivers Kick Panel
				Parking Lights	-	-	-	LT. BLUE	(-)	Headlight Switch
				Horn	-	-	-	TAN	(-)	Horn Switch
				RAP Shutdown	-	-	-	GRAY/BLACK	(-)	Drivers Kick Panel Harness From Door
GMC	Sierra 1500	6 Cyl. Automatic 8 Cyl. Automatic	2007 - 2013	12 Volts	-	-	-	RED/BLACK	(+)	Drivers Fuse Box
				Parking Lights	-	-	-	LT. BLUE	(-)	Headlight Switch
				Horn	BROWN	25	18	TAN	(-)	BCM Center of Driver Dash Below Steering Column
				RAP Shutdown	Covered Via Data					
GMC	Sierra 1500	Hybrid Automatic w/ Premium Package 6/8 Cyl. Automatic	2007 - 2013	12 Volts	-	-	-	RED/BLACK	(+)	Drivers Fuse Box
				Parking Lights	-	-	-	LT. BLUE	(-)	Headlight Switch
				Horn	BROWN	25	18	TAN	(-)	BCM Center of Driver Dash Below Steering Column
				RAP Shutdown	Covered Via Data					
GMC	Sierra 2500/3500	8 Cyl. Automatic Diesel Automatic	2007 - 2014	12 Volts	-	-	-	RED/BLACK	(+)	Drivers Fuse Box
				Parking Lights	-	-	-	LT. BLUE	(-)	Headlight Switch
				Horn	BROWN	25	18	TAN	(-)	BCM Center of Driver Dash Below Steering Column
				RAP Shutdown	Covered Via Data					
GMC	Yukon	8 Cyl. Automatic Hybrid Automatic	2007 - 2014	12 Volts	-	-	-	RED/BLACK	(+)	Drivers Fuse Box
				Parking Lights	-	-	-	LT. BLUE	(-)	Headlight Switch
				Horn	BROWN	25	18	TAN	(-)	BCM Center of Driver Dash Below Steering Column
				RAP Shutdown	Covered Via Data					
Hummer	H2	8 Cyl. Automatic	2008 - 2009	12 Volts	-	-	-	RED/BLACK	(+)	Drivers Fuse Box
				Parking Lights	-	-	-	LT. BLUE	(-)	Headlight Switch
				Horn	BROWN	25	18	TAN	(-)	BCM Center of Driver Dash Below Steering Column
				RAP Shutdown	Covered Via Data					

MODEL: OL-HRN-RS-GM10

RSX-G6 Diagram #1

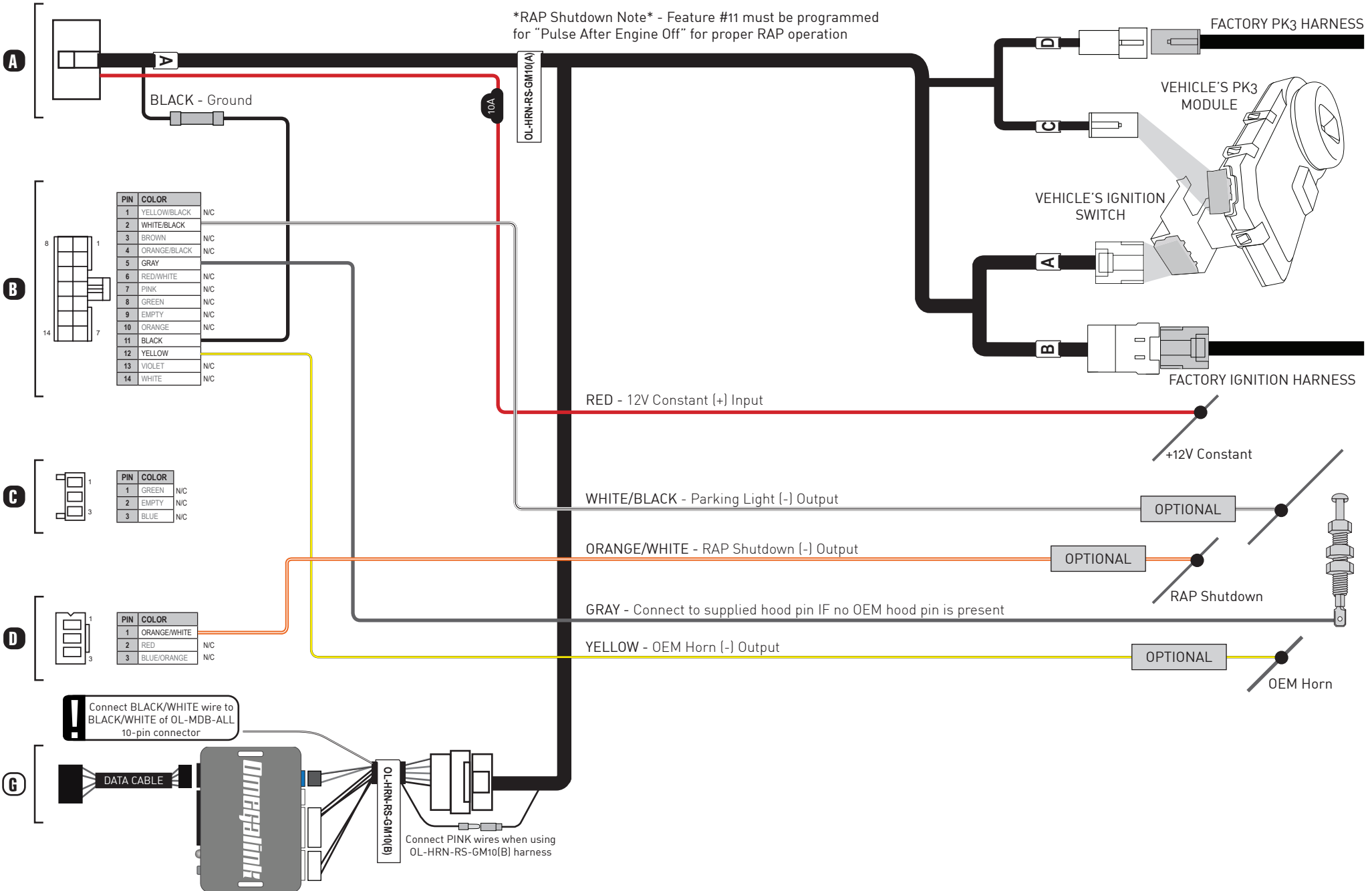

MODEL: OL-HRN-RS-GM10

Wire Location Chart Diagram #2

Make	Model	Trim	Year	Item	Connector Color	Connector Pins	Pin #	Wire Color	Polarity	Location
Buick	Enclave	6 Cyl. Automatic	2008 - 2017	12 Volts	BLACK	25	2	RED/WHITE	(+)	BCM Left Side Of Steering Column
				Parking Lights	WHITE	25	8	BROWN/WHITE	(-)	BCM Left Side Of Steering Column
				Horn	BROWN	25	18	TAN	(-)	BCM Left Side Of Steering Column
				RAP Shutdown	Covered Via Data					
Chevrolet	Caprice	Sedan 8 Cyl. Automatic	2011 - 2013	12 Volts	BLACK	25	1	RED/WHITE or ORANGE/RED	(+)	BCM Right Side Of Steering Column
				Parking Lights	WHITE	25	8	BROWN/WHITE	(-)	BCM Right Side Of Steering Column
				Horn	BROWN	25	18	BROWN/BLACK	(-)	BCM Right Side Of Steering Column
				RAP Shutdown	Covered Via Data					
Chevrolet	Traverse	6 Cyl. Automatic	2009 - 2017	12 Volts	BLACK	25	1	RED/WHITE	(+)	BCM Left Side Of Steering Column
				Parking Lights	WHITE	25	8	BROWN/WHITE	(-)	BCM Left Side Of Steering Column
				Horn	BROWN	25	18	TAN	(-)	BCM Left Side Of Steering Column
				RAP Shutdown	PINK	25	10	GRAY/BLACK	(-)	BCM Left Side Of Steering Column
Chevrolet	Traverse	w/ Auto Window Up/Down 6 Cyl. Automatic	2009 - 2017	12 Volts	BLACK	25	1	RED/WHITE	(+)	BCM Left Side Of Steering Column
				Parking Lights	WHITE	25	8	BROWN/WHITE	(-)	BCM Left Side Of Steering Column
				Horn	BROWN	25	18	TAN	(-)	BCM Left Side Of Steering Column
				RAP Shutdown	Covered Via Data					
GMC	Acadia	6 Cyl. Automatic	2007 - 2016	12 Volts	BLACK	25	1	RED/WHITE	(+)	BCM Left Side Of Steering Column
				Parking Lights	WHITE	25	8	BROWN/WHITE	(-)	BCM Left Side Of Steering Column
				Horn	BROWN	25	18	TAN	(-)	BCM Left Side Of Steering Column
				RAP Shutdown	PINK	25	10	GRAY/BLACK	(-)	BCM Left Side Of Steering Column
GMC	Acadia	w/ Auto Window Up/Down 6 Cyl. Automatic	2007 - 2016	12 Volts	BLACK	25	1	RED/WHITE	(+)	BCM Left Side Of Steering Column
				Parking Lights	WHITE	25	8	BROWN/WHITE	(-)	BCM Left Side Of Steering Column
				Horn	BROWN	25	18	TAN	(-)	BCM Left Side Of Steering Column
				RAP Shutdown	Covered Via Data					
GMC	Acadia Limited	Automatic	2017 - 2017	12 Volts	BLACK	25	1	RED/WHITE	(+)	BCM Left Side Of Steering Column
				Parking Lights	WHITE	25	8	BROWN/WHITE	(-)	BCM Left Side Of Steering Column
				Horn	BROWN	25	18	TAN	(-)	BCM Left Side Of Steering Column
				RAP Shutdown	Covered Via Data					
Pontiac	G8	Sedan 6 Cyl. Automatic Sedan 8 Cyl. Automatic	2008 - 2009	12 Volts	BLACK	25	1	RED/WHITE	(+)	BCM Right Side Of Steering Column
				Parking Lights	WHITE	25	8	BROWN/WHITE	(-)	BCM Right Side Of Steering Column
				Horn	BROWN	25	18	BROWN/BLACK	(-)	BCM Right Side Of Steering Column
				RAP Shutdown	PINK	25	10	GRAY/BLACK	(-)	BCM Right Side Of Steering Column

MODEL: OL-HRN-RS-GM10

Wire Location Chart Diagram #2

Make	Model	Trim	Year	Item	Connector Color	Connector Pins	Pin #	Wire Color	Polarity	Location
Saturn	Outlook	6 Cyl. Automatic	2007 - 2010	12 Volts	BLACK	25	1	RED/WHITE	(+)	BCM Left Side Of Steering Column
				Parking Lights	WHITE	25	8	BROWN/WHITE	(-)	BCM Left Side Of Steering Column
				Horn	BROWN	25	18	TAN	(-)	BCM Left Side Of Steering Column
				RAP Shutdown	PINK	25	10	GRAY/BLACK	(-)	BCM Left Side Of Steering Column
Saturn	Outlook	w/ Auto Window Up/Down 6 Cyl. Automatic	2007 - 2010	12 Volts	BLACK	25	1	RED/WHITE	(+)	BCM Left Side Of Steering Column
				Parking Lights	WHITE	25	8	BROWN/WHITE	(-)	BCM Left Side Of Steering Column
				Horn	BROWN	25	18	TAN	(-)	BCM Left Side Of Steering Column
				RAP Shutdown	Covered Via Data					

MODEL: OL-HRN-RS-GM10

RSX-G6 Diagram #2

RAP Shutdown Note - Feature #11 must be programmed for "Pulse After Engine Off" for proper RAP operation

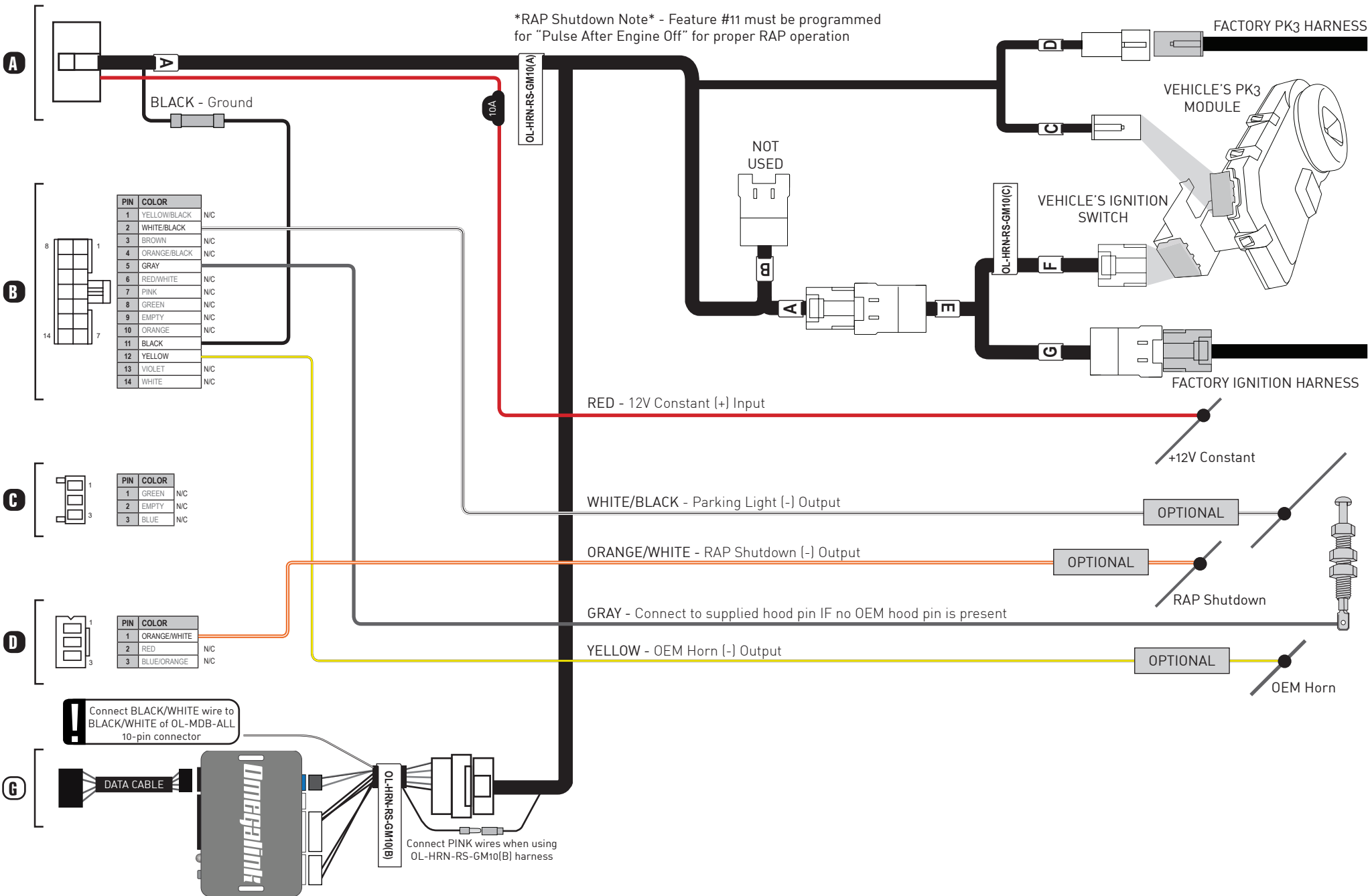

MODEL: OL-HRN-RS-GM10

Wire Location Chart Diagram #3

Make	Model	Trim	Year	Item	Connector Color	Connector Pins	Pin #	Wire Color	Polarity	Location
Buick	Lucerne	Sedan 6 Cyl. Automatic Sedan 8 Cyl. Automatic	2006 - 2011	12 Volts	BLACK	25	1	RED/YELLOW	(+)	BCM Passenger Side Dashboard
				Ignition	BLACK	6	1	PINK	(+)	Ignition Switch
				Passlock	BLACK	6	5	WHITE	MUX	Ignition Switch
				Parking Lights	WHITE	25	8	LT. BLUE/TAN	(-)	BCM Passenger Side Dashboard
				Horn	BROWN	25	18	TAN	(-)	BCM Passenger Side Dashboard
				RAP Shutdown	Covered Via Data					
Cadillac	CTS	Coupe 6 Cyl. Automatic	2010 - 2011	12 Volts	BLACK	25	2	RED/WHITE	(+)	BCM Passenger Side Dashboard
				Ignition	BLACK	6	1	PINK	(+)	Ignition Switch
				Passlock	BLACK	6	5	WHITE	MUX	Ignition Switch
				Parking Lights	WHITE	25	8	BROWN/WHITE	(-)	BCM Passenger Side Dashboard
				Horn	BROWN	25	18	BLACK	(-)	BCM Passenger Side Dashboard
				RAP Shutdown	Covered Via Data					
Cadillac	CTS	Estate/Wagon 6 Cyl. Automatic	2009 - 2014	12 Volts	BLACK	25	2	RED/WHITE	(+)	BCM Right Side Of Steering Column
				Ignition	BLACK	6	1	PINK	(+)	Ignition Switch
				Passlock	BLACK	6	5	WHITE	MUX	Ignition Switch
				Parking Lights	WHITE	25	8	BROWN/WHITE	(-)	BCM Right Side Of Steering Column
				Horn	BROWN	25	18	BLACK	(-)	BCM Right Side Of Steering Column
				RAP Shutdown	Covered Via Data					
Cadillac	CTS	Sedan 6 Cyl. Automatic	2008 - 2013	12 Volts	BLACK	25	2	RED/WHITE	(+)	BCM Right Side Of Steering Column
				Ignition	BLACK	6	1	PINK	(+)	Ignition Switch
				Passlock	BLACK	6	5	WHITE	MUX	Ignition Switch
				Parking Lights	WHITE	25	8	BROWN/WHITE	(-)	BCM Right Side Of Steering Column
				Horn	BROWN	25	18	BLACK	(-)	BCM Right Side Of Steering Column
				RAP Shutdown	Covered Via Data					
Cadillac	CTS-V	Sedan 8 Cyl. Automatic	2009 - 2011	12 Volts	BLACK	25	2	RED/WHITE	(+)	BCM Right Side Of Steering Column
				Ignition	BLACK	6	1	PINK	(+)	Ignition Switch
				Passlock	BLACK	6	5	WHITE	MUX	Ignition Switch
				Parking Lights	WHITE	25	8	BROWN/WHITE	(-)	BCM Right Side Of Steering Column
				Horn	BROWN	25	18	BLACK	(-)	BCM Right Side Of Steering Column
				RAP Shutdown	Covered Via Data					
Cadillac	DTS	Sedan 8 Cyl. Automatic	2006 - 2011	12 Volts	BLACK	25	1	RED/YELLOW	(+)	BCM Right Side Of Steering Column
				Ignition	BLACK	6	1	PINK	(+)	Ignition Switch
				Passlock	BLACK	6	5	WHITE	MUX	Ignition Switch
				Parking Lights	WHITE	25	8	LT. BLUE	(-)	BCM Right Side Of Steering Column
				Horn	BROWN	25	18	TAN	(-)	BCM Right Side Of Steering Column
				RAP Shutdown	Covered Via Data					

MODEL: OL-HRN-RS-GM10

Wire Location Chart Diagram #3

Make	Model	Trim	Year	Item	Connector Color	Connector Pins	Pin #	Wire Color	Polarity	Location
Cadillac	SRX	6 Cyl. Automatic 8 Cyl. Automatic	2007 - 2009	12 Volts	BLACK	25	2	RED/WHITE	(+)	BCM Left of Steering Column
				Ignition	BLACK	6	2	PINK	(+)	Ignition Switch
				Passlock	BLACK	6	5	WHITE	MUX	Ignition Switch
				Parking Lights	WHITE	25	8	BROWN/WHITE	(-)	BCM Left of Steering Column
				Horn	BROWN	-	18	TAN	(-)	BCM Left of Steering Column
				RAP Shutdown	Covered Via Data					
Chevrolet	Captiva Sport	4 Cyl. Automatic Hybrid Automatic	2008 - 2015	12 Volts	BLACK	25	1	RED/WHITE	(+)	BCM Below Radio
				Ignition	BLACK	6	1	PINK	(+)	Ignition Switch
				Passlock	BLACK	6	5	WHITE/BLACK	MUX	Ignition Switch
				Parking Lights	WHITE	25	8	LT. BLUE	(-)	BCM Below Radio
				Horn	BROWN	25	18	TAN	(-)	BCM Below Radio
				RAP Shutdown	Covered Via Data					
Chevrolet	Captiva Sport	6 Cyl. Automatic	2008 - 2015	12 Volts	BLACK	25	1	RED/WHITE	(+)	BCM Below Radio
				Ignition	BLACK	6	1	PINK	(+)	Ignition Switch
				Passlock	BLACK	6	5	WHITE/BLACK	MUX	Ignition Switch
				Parking Lights	WHITE	25	8	LT. BLUE	(-)	BCM Below Radio
				Horn	BROWN	25	18	TAN	(-)	BCM Below Radio
				RAP Shutdown	Covered Via Data					
Chevrolet	Equinox	6 Cyl. Automatic	2007 - 2009	12 Volts	BLACK	25	2	RED/WHITE	(+)	BCM Passenger Side Dashboard
				Ignition	BLACK	6	1	PINK	(+)	Ignition Switch
				Passlock	BLACK	6	5	WHITE	MUX	Ignition Switch
				Parking Lights	WHITE	25	8	BROWN/WHITE	(-)	BCM Passenger Side Dashboard
				Horn	BROWN	25	18	TAN	(-)	BCM Passenger Side Dashboard
				RAP Shutdown	PINK	25	10	GRAY/BLACK	(-)	BCM Passenger Side Dashboard
Chevrolet	Impala	Sedan 6 Cyl. Automatic Sedan 8 Cyl. Automatic	2006 - 2013	12 Volts	BLACK	25	2	RED/WHITE	(+)	BCM Left Side Of Steering Column
				Ignition	BLACK	6	1	PINK	(+)	Ignition Switch
				Passlock	BLACK	6	5	WHITE	MUX	Ignition Switch
				Parking Lights	WHITE	25	8	BROWN/WHITE	(-)	BCM Left Side Of Steering Column
				Horn	BROWN	25	18	TAN	(-)	BCM Left Side Of Steering Column
				RAP Shutdown	PINK	25	10	GRAY/BLACK	(-)	BCM Left Side Of Steering Column
Chevrolet	Impala Limited	Sedan 6 Cyl. Automatic	2014 - 2016	12 Volts	BLACK	25	2	RED/WHITE	(+)	BCM Left Side Of Steering Column
				Ignition	BLACK	6	1	PINK	(+)	Ignition Switch
				Passlock	BLACK	6	5	WHITE	(-)	Ignition Switch
				Parking Lights	WHITE	25	8	BROWN/WHITE	(-)	BCM Left Side Of Steering Column
				Horn	BROWN	25	18	TAN	(-)	BCM Left Side Of Steering Column
				RAP Shutdown	PINK	25	10	GRAY/BLACK	(-)	BCM Left Side Of Steering Column

MODEL: OL-HRN-RS-GM10

Wire Location Chart Diagram #3

Make	Model	Trim	Year	Item	Connector Color	Connector Pins	Pin #	Wire Color	Polarity	Location
Chevrolet	Monte Carlo	Coupe 6 Cyl. Automatic Coupe 8 Cyl. Automatic	2006 - 2007	12 Volts	BLACK	25	2	RED/WHITE	(+)	BCM Left Side Of Steering Column
				Ignition	BLACK	6	1	PINK	(+)	Ignition Switch
				Passlock	BLACK	6	5	WHITE	(-)	Ignition Switch
				Parking Lights	WHITE	25	8	BROWN/WHITE	(-)	BCM Left Side Of Steering Column
				Horn	BROWN	25	18	TAN	(-)	BCM Left Side Of Steering Column
				RAP Shutdown	PINK	25	10	GRAY/BLACK	(-)	BCM Left Side Of Steering Column
Pontiac	Torrent	6 Cyl. Automatic	2007 - 2009	12 Volts	BLACK	25	2	RED/WHITE	(+)	BCM Left Side Of Steering Column
				Ignition	BLACK	6	1	PINK	(+)	Ignition Switch
				Passlock	BLACK	6	5	WHITE	MUX	Ignition Switch
				Parking Lights	WHITE	25	8	BROWN/WHITE	(-)	BCM Left Side Of Steering Column
				Horn	BROWN	25	18	TAN	(-)	BCM Left Side Of Steering Column
				RAP Shutdown	PINK	25	10	GRAY/BLACK	(-)	BCM Left Side Of Steering Column
Saturn	VUE	4 Cyl. Automatic Hybrid Automatic	2008 - 2010	12 Volts	BLACK	25	2	RED/WHITE	(+)	BCM Under Radio
				Ignition	BLACK	6	1	PINK	(+)	Ignition Switch
				Passlock	BLACK	6	5	WHITE	MUX	Ignition Switch
				Parking Lights	WHITE	25	8	BROWN/WHITE	(-)	BCM Under Radio
				Horn	BROWN	25	18	TAN	(-)	BCM Under Radio
				RAP Shutdown	PINK	25	10	GRAY/BLACK	(-)	BCM Under Radio
Saturn	VUE	6 Cyl. Automatic	2008 - 2010	12 Volts	BLACK	25	1	RED/WHITE	(+)	BCM Under Radio
				Ignition	BLACK	6	2	PINK	(+)	Ignition Switch
				Passlock	BLACK	6	4	WHITE/BLACK	MUX	Ignition Switch
				Parking Lights	WHITE	25	8	LT. BLUE	(-)	BCM Under Radio
				Horn	BROWN	25	18	TAN	(-)	BCM Under Radio
				RAP Shutdown	PINK	25	10	GRAY/BLACK	(-)	BCM Under Radio
Suzuki	XL-7	6 Cyl. Automatic	2007 - 2009	12 Volts	BLACK	25	2	RED/WHITE	(+)	BCM Under Radio
				Ignition	BLACK	6	1	PINK	(+)	Ignition Switch
				Passlock	BLACK	6	5	WHITE	(-)	Ignition Switch
				Parking Lights	WHITE	25	8	BROWN/WHITE	(-)	BCM Under Radio
				Horn	BROWN	25	18	TAN	(-)	BCM Under Radio
				RAP Shutdown	PINK	25	10	GRAY/BLACK	(-)	BCM Under Radio

MODEL: OL-HRN-RS-GM10

RSX-G6 Diagram #3

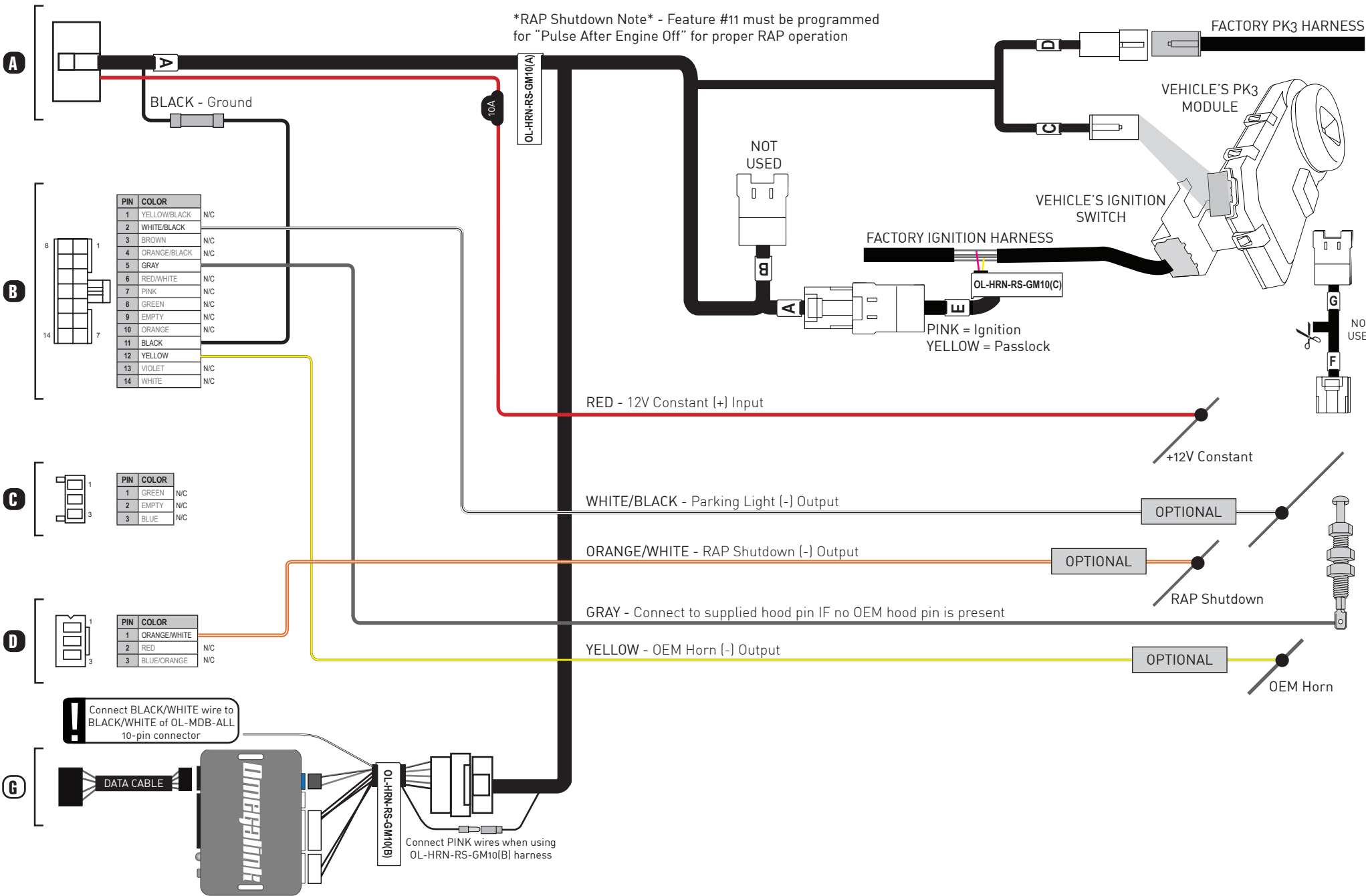

Wire Location Chart Diagram #4

Make	Model	Trim	Year	Item	Connector Color	Connector Pins	Pin #	Wire Color	Polarity	Location
Pontiac	G8	Sedan 6 Cyl. Manual Sedan 8 Cyl. Manual	2008 - 2009	12 Volts	BLACK	25	1	RED/WHITE or ORANGE/RED	(+)	BCM Right Side Of Steering Column
				Parking Lights	WHITE	25	8	BROWN/WHITE	(-)	BCM Right Side Of Steering Column
				Horn	BROWN	25	18	BROWN/BLACK	(-)	BCM Right Side Of Steering Column
				RAP Shutdown	PINK	25	10	GRAY/BLACK	(-)	BCM Right Side Of Steering Column
				Parking Brake	BROWN	25	16	ORANGE/BLACK	(-)	BCM Right Side Of Steering Column
				Clutch Bypass	BLACK	3	B	YELLOW	MUX	Clutch Switch

MODEL: OL-HRN-RS-GM10

RSX-G6 Diagram #4

RAP Shutdown Note - Feature #11 must be programmed for "Pulse After Engine Off" for proper RAP operation

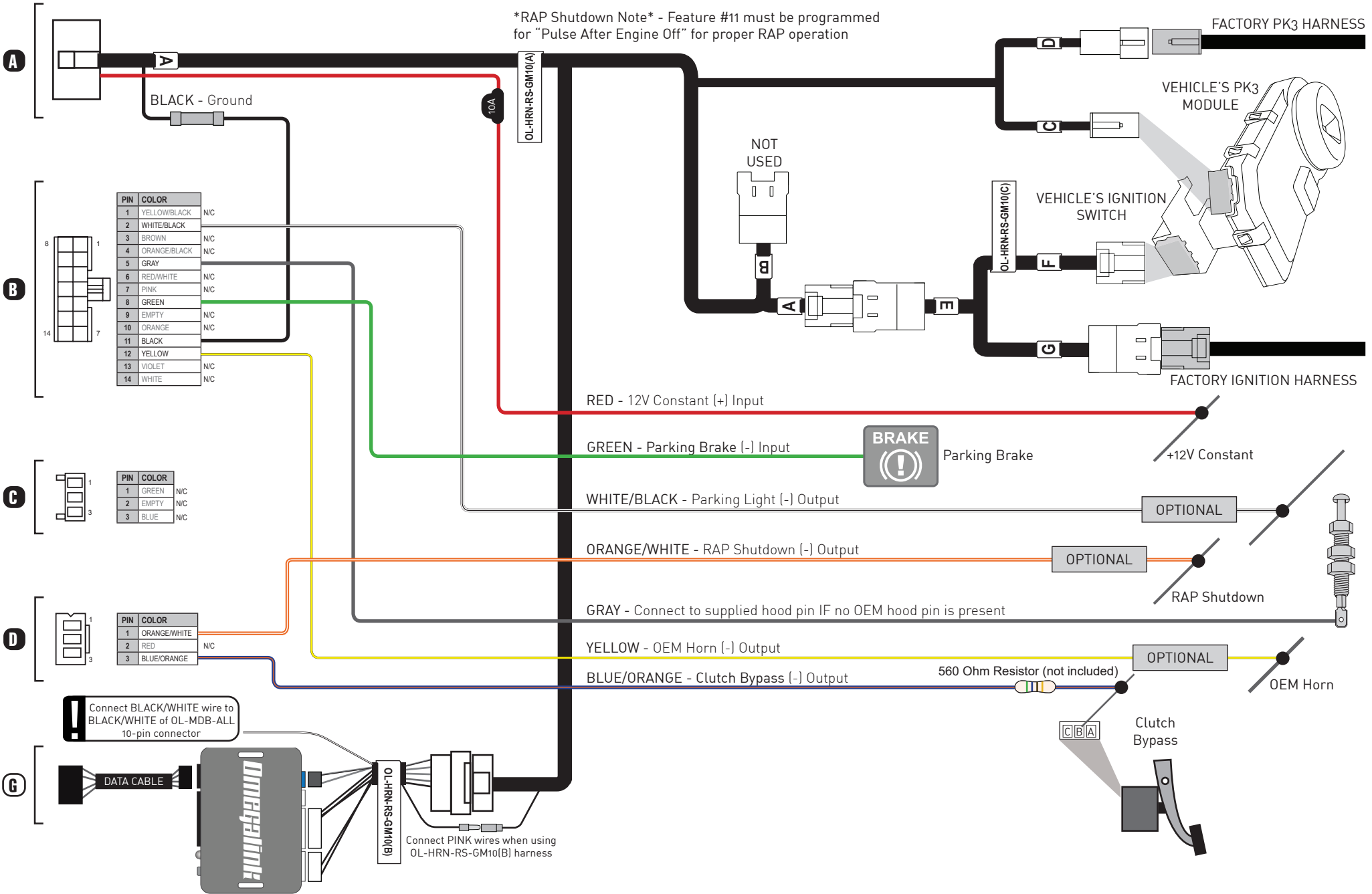

MODEL: OL-HRN-RS-GM10

Wire Location Chart Diagram #5

Make	Model	Trim	Year	Item	Connector Color	Connector Pins	Pin #	Wire Color	Polarity	Location			
Cadillac	CTS	Coupe 6 Cyl. Manual	2010 - 2013	12 Volts	BLACK	25	2	RED/WHITE	(+)	BCM Right Of Steering Column			
				Ignition	BLACK	6	1	PINK	(+)	Ignition Switch			
				Passlock	BLACK	6	5	WHITE	MUX	Ignition Switch			
				Parking Lights	WHITE	25	8	BROWN/WHITE	(-)	BCM Right Of Steering Column			
				Horn	BROWN	25	18	BLACK	(-)	BCM Right Of Steering Column			
				RAP Shutdown	Covered Via Data								
				Parking Brake	BROWN	25	16	ORANGE/BLACK	(-)	BCM Right Of Steering Column			
				Clutch Bypass	BLACK	3	B	TAN or LT. GREEN	MUX	Clutch Switch			
Cadillac	CTS	Estate/Wagon 6 Cyl. Manual	2009 - 2013	12 Volts	BLACK	25	2	RED/WHITE	(+)	BCM Right Of Steering Column			
				Ignition	BLACK	6	1	PINK	(+)	Ignition Switch			
				Passlock	BLACK	6	5	WHITE	MUX	Ignition Switch			
				Parking Lights	WHITE	25	8	BROWN/WHITE	(-)	BCM Right Of Steering Column			
				Horn	BROWN	25	18	BLACK	(-)	BCM Right Of Steering Column			
				RAP Shutdown	Covered Via Data								
				Parking Brake	BROWN	25	16	ORANGE/BLACK	(-)	BCM Right Of Steering Column			
				Clutch Bypass	BLACK	3	B	TAN or LT. GREEN	MUX	Clutch Switch			
Cadillac	CTS	Sedan 6 Cyl. Manual	2008 - 2013	12 Volts	BLACK	25	2	RED/WHITE	(+)	BCM Right Of Steering Column			
				Ignition	BLACK	6	1	PINK	(+)	Ignition Switch			
				Passlock	BLACK	6	5	WHITE	MUX	Ignition Switch			
				Parking Lights	WHITE	25	8	BROWN/WHITE	(-)	BCM Right Of Steering Column			
				Horn	BROWN	25	18	BLACK	(-)	BCM Right Of Steering Column			
				RAP Shutdown	Covered Via Data								
				Parking Brake	BROWN	25	16	ORANGE/BLACK	(-)	BCM Right Of Steering Column			
				Clutch Bypass	BLACK	3	B	TAN or LT. GREEN	MUX	Clutch Switch			
Cadillac	CTS-V	Sedan 8 Cyl. Manual	2009 - 2011	12 Volts	BLACK	25	2	RED/WHITE	(+)	BCM Right Of Steering Column			
				Ignition	BLACK	6	1	PINK	(+)	Ignition Switch			
				Passlock	BLACK	6	5	WHITE	MUX	Ignition Switch			
				Parking Lights	WHITE	25	8	BROWN/WHITE	(-)	BCM Right Of Steering Column			
				Horn	BROWN	25	18	BLACK	(-)	BCM Right Of Steering Column			
				RAP Shutdown	Covered Via Data								
				Parking Brake	BROWN	25	16	ORANGE/BLACK	(-)	BCM Right Of Steering Column			
				Clutch Bypass	BLACK	3	B	TAN or LT. GREEN	MUX	Clutch Switch			

MODEL: OL-HRN-RS-GM10

RSX-G6 Diagram #5

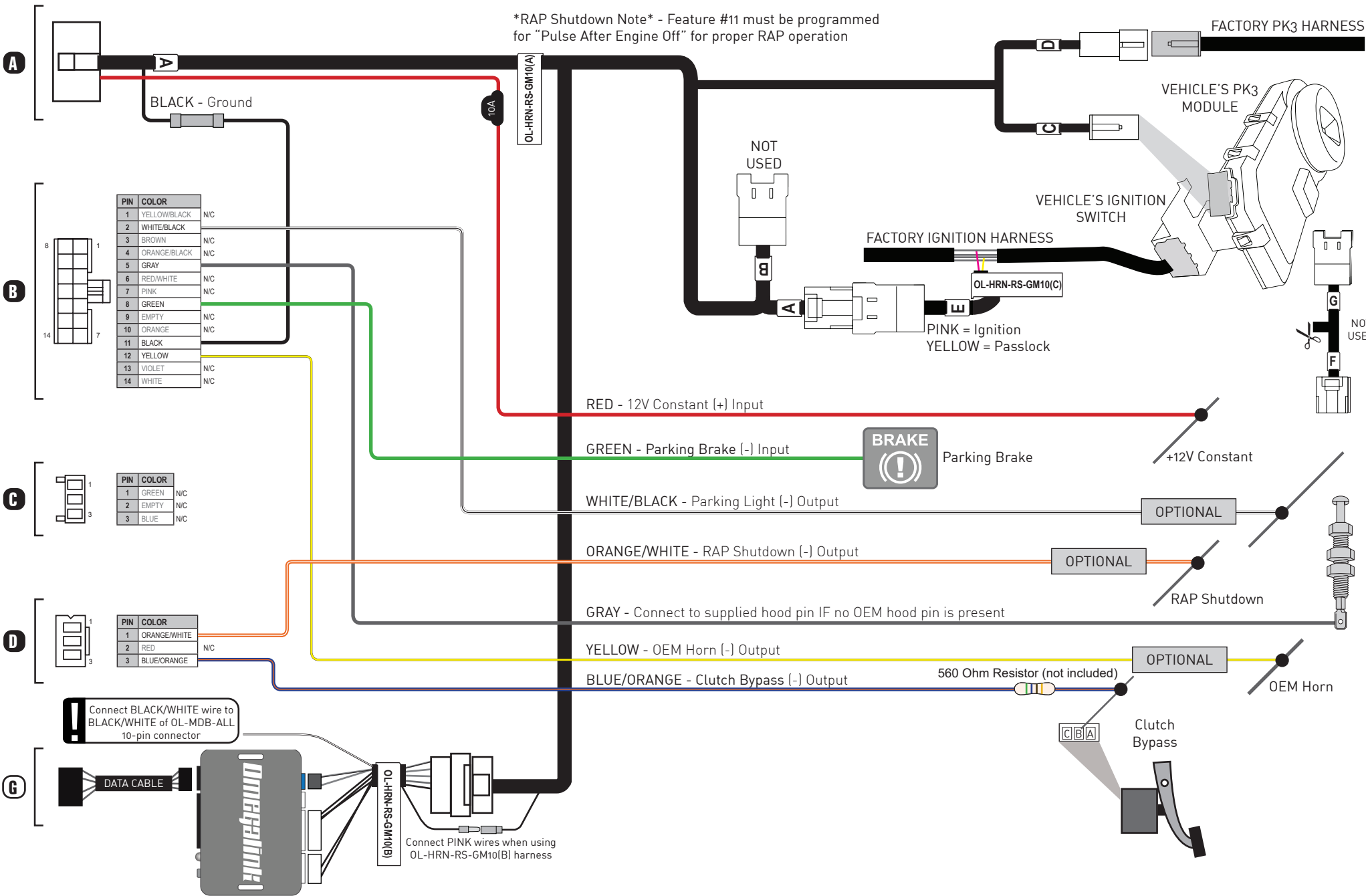

RSX-G6 Optional Accessories

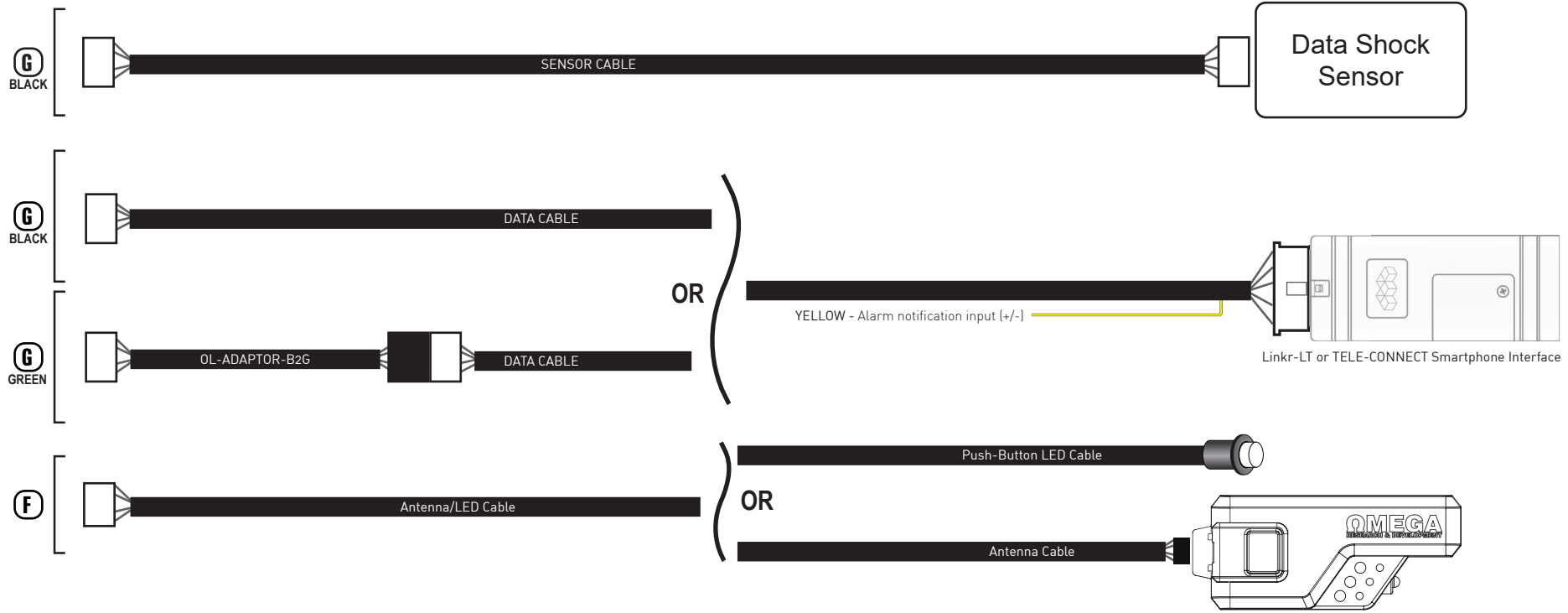

Installation Mode Selection

- 1 Press and release programming button to select installation mode.

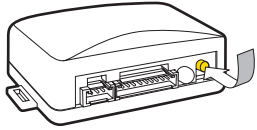

- LED flashes (1x) once = Data Mode (Recommended)
- LED flashes (2x) twice = Hardwire Mode

- 2 Press and hold programming button until LED turns solid GREEN to register selection.

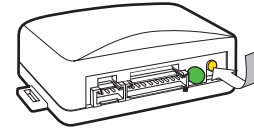

After registration, follow Factory Reset to change installation mode and restart this process.

Module Programming

- 1 Close driver door.
Re-open driver door to wake up data bus

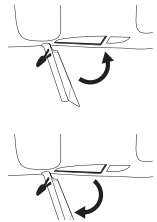

- 2 Insert the key into the ignition.

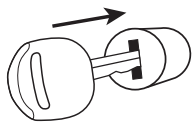

- 3 Turn the key to the ON position.

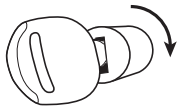

- 4 Wait, LED will turn solid GREEN for 2 seconds. (This could take up to 1 minute)

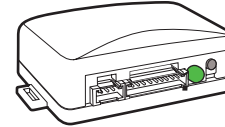

- 5 Turn the key to the OFF position.

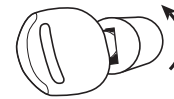

- 6 Proceed to RSX-G6 Programming/Vehicle Learn.

RSX-G6 Programming/Vehicle Learn

Before You Begin:

- Make sure all wires/harnesses are connected.
- Program the bypass module to the vehicle per the instructions on the previous pages.
- Connect any additional accessories/modules to the data ports.
- **MANUAL TRANSMISSION VEHICLES ONLY:** Change feature #6 to desired setup process. Connect the GREEN wire to the vehicles parking brake and set the parking brake.

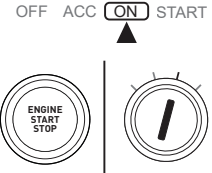
1 OFF ACC **ON** START
 Turn ignition to ON position (do not start).

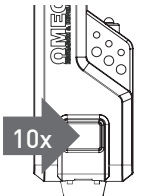
2
 Press the Valet button 8x within 10 seconds

- The system will chirp & flash lights to indicate crank delay (Default: 1 chirp/flash = 1.5 sec)
- **Optional:** Press valet button to change crank delay- Chirps: 1=1.5 sec, 2=15 sec, 3=20 sec, 4=30 sec

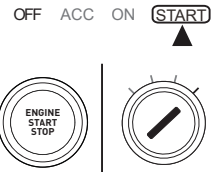
3 OFF ACC ON **START**
 Start the engine with the key and let the engine reach normal idle.

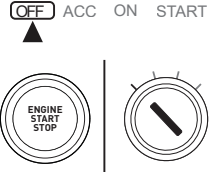
4 OFF ACC ON START
 **AUTOMATIC TRANSMISSIONS:**
 Turn the ignition key OFF.

- The system will chirp & flash the lights equal the # of IGN/ACC/START circuits detected (Max: 4).

MANUAL TRANSMISSIONS:
 Release the parking brake.

- The system will chirp & flash the lights equal the # of IGN/ACC/START circuits detected (Max: 4).

Set the parking brake again.
 Before turning the key OFF, perform the selected MT rerevation sequence (feature #6)

5
 **PUSH-BUTTON-START VEHICLES:**
 Exit the vehicle and take the OEM fob/key 20 feet away to allow remote start.

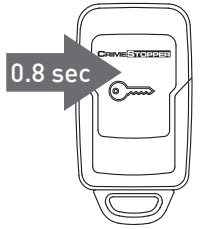
6
 Activate remote start (feature #16) within 60 sec. Wait until engine is running and LED flashes slowly (10-45 seconds after engine cranks & runs).

- The system will detect data protocols, select the best available engine running detection method, and, learn any available tach input (data or analog).

7
 **TO SAVE SETTINGS/FINISH VEHICLE LEARN:**
 Press the BRAKE pedal (will shut down RS).

- This disables VEHICLE LEARN (to enable again, program installer feature #2 (bank 10) to "Enabled").

TO CANCEL/START OVER:
 Press the valet button once.

8 Programming complete.

Troubleshooting

- See system installation guide for remote start diagnostics and troubleshooting.
- See OmegaLink module/firmware guide at www.wiresheet.com for interface module diagnostics and troubleshooting.