



MODEL
OL-HRN-RS-HA3

GUIDE ID
CST_HA3_G6_G5_20210419

AVAILABLE ACCESSORIES

OL-HRN-RS-PWR
(Adapt to any brand remote start w/ BLADE or OL-MDB-ALL / FL-CAN / ADS-AL-CA)

VEHICLE COMPATIBILITY

For RSX-G5 installations see pages 3-14
(OL-HRN-RS-PWR-CST not included but required for G5 units)
For RSX-G6 installations see pages 15-27

Make	Model	Trim	Years	Firmware	Diagram	Adaptor
Acura	TL	Std. Key Sedan 6 Cyl. Automatic	2009-2014	DL-HA3	2	HA3(D)
Acura	TL	Std. Key Sedan 6 Cyl. Manual	2009-2014	DL-HA3	4	HA3(D)
Acura	TSX	Std. Key Sedan 4 Cyl. Automatic	2009-2014	DL-HA3	2	HA3(D)
Acura	TSX	Std. Key Sedan 4 Cyl. Manual	2009-2014	DL-HA3	4	HA3(D)
Acura	TSX	Std. Key Sedan 6 Cyl. Automatic	2010-2014	DL-HA3	2	HA3(D)
Acura	TSX	Std. Key Estate/Wagon 4 Cyl. Automatic	2012-2014	DL-HA3	2	HA3(D)
Acura	ZDX	Std. Key SUV 6 Cyl. Automatic	2010-2012	DL-HA3	2	HA3(D)
Honda	Accord	Std. Key Coupe 4/6 Cyl. Automatic	2008-2012	DL-HA3	2	HA3(D)
Honda	Accord	Std. Key Coupe 4/6 Cyl. Manual	2008-2012	DL-HA3	4	HA3(D)
Honda	Accord	Std. Key Sedan 4/6 Cyl. Automatic	2008-2012	DL-HA3	2	HA3(D)
Honda	Accord	Std. Key Sedan 4 Cyl. Manual	2008-2012	DL-HA3	4	HA3(D)
Honda	Accord	Std. Key 4 Cyl. Automatic	2013-2017	DL-HA6	1	HA3(C)
Honda	Accord	Std. Key 4 Cyl. Manual	2013-2017	DL-HA6	3	HA3(C)
Honda	Accord Crosstour	Std. Key SUV 4/6 Cyl. Automatic	2010-2012	DL-HA3	2	HA3(D)

DISCLAIMER: The manufacturer of this product nor its affiliates accept any responsibility for any electrical damage to the vehicle or any other connected systems as a result of improper installation of this product. All wiring connections & vehicle compatibility must be verified by a professionally qualified technician prior to installation.

MODEL: OL-HRN-RS-HA3

Make	Model	Trim	Years	Firmware	Diagram	Adaptor
Honda	Accord Crosstour	Std. Key SUV 4 Cyl. Automatic	2013-2015	DL-HA6	1	HA3(C)
Honda	Civic	Std. Key Coupe 4 Cyl. Automatic	2012-2013	DL-HA3	1	HA3(C)
Honda	Civic	Std. Key Coupe 4 Cyl. Manual	2012-2013	DL-HA3	3	HA3(C)
Honda	Civic	Std. Key Sedan 4 Cyl. Automatic	2012-2013	DL-HA3	1	HA3(C)
Honda	Civic	Std. Key Sedan 4 Cyl. Manual	2012-2013	DL-HA3	3	HA3(C)
Honda	Civic	Std. Key Sedan Hybrid Automatic	2012-2013	DL-HA3	1	HA3(C)
Honda	Civic	Std. Key 4 Cyl. Automatic	2014-2015	DL-HA3	1	HA3(C)
Honda	Civic	Std. Key 4 Cyl. Manual	2014-2015	DL-HA3	3	HA3(C)
Honda	Civic	Std. Key 4 Cyl. Automatic	2016-2021	DL-HA6	1	HA3(C)
Honda	Civic	Std. Key 4 Cyl. Manual	2016-2021	DL-HA6	3	HA3(C)
Honda	Civic Si	Std. Key Coupe 4 Cyl. Manual	2012-2013	DL-HA3	3	HA3(C)
Honda	Civic Si	Std. Key Sedan 4 Cyl. Manual	2012-2013	DL-HA3	3	HA3(C)
Honda	CR-V	Std. Key SUV 4 Cyl. Automatic	2017-2021	DL-HA6	1	HA3(C)
Honda	CR-V	Std. Key SUV 4 Cyl. Automatic	2012-2016	DL-HA3	1	HA3(C)
Honda	Fit	Std. Key 4 Dr Hatchback 4 Cyl. Automatic	2015-2020	DL-HA6	1	HA3(C)
Honda	Fit	Std. Key 4 Dr Hatchback 4 Cyl. Manual	2015-2020	DL-HA6	3	HA3(C)
Honda	HR-V	Std. Key SUV Automatic	2016-2021	DL-HA6	1	HA3(C)
Honda	HR-V	Std. Key SUV Manual	2016-2021	DL-HA6	3	HA3(C)
Honda	Odyssey	Std. Key Minivan 6 Cyl. Automatic	2011-2017	DL-HA3	2	HA3(C)
Honda	Pilot	Std. Key SUV 6 Cyl. Automatic	2009-2015	DL-HA3	2	HA3(D)

To ensure the steering column cover will re-install properly the harness is designed to allow the OEM harness to be pulled back into the dash and the OL-HRN-RS-HA3 harness connector "A" to be routes in its place.

RSX-G5 Layout

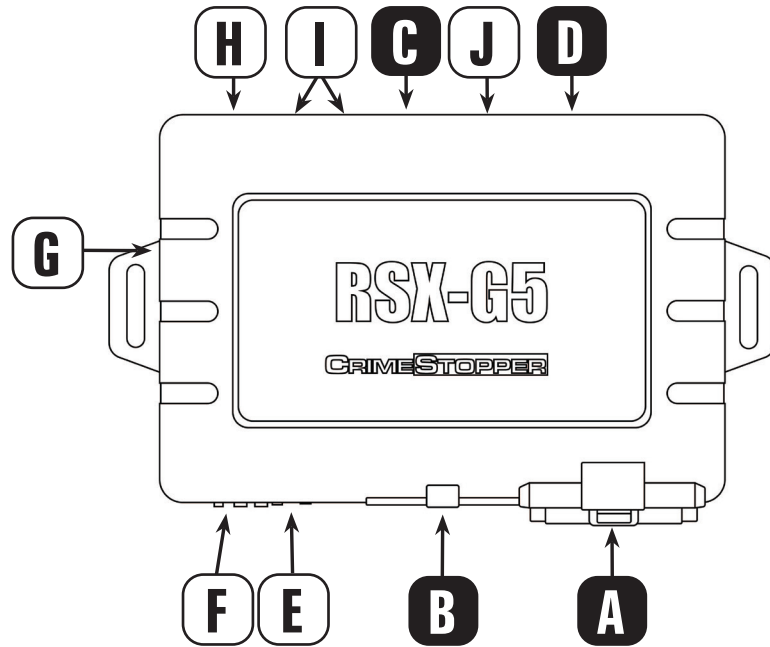

- A** BLACK 6 PIN HIGH CURRENT POWER HARNESS
NOTE: OL-HRN-RS-PWR-CST Adaptor Not Included With T-Harness & Will Be Required
- B** WHITE 12 PIN MAIN INPUT/OUTPUT HARNESS
- C** WHITE 3 PIN DOOR LOCK PORT
- D** RED 3 PIN LOW CURRENT AUX PORT
- E** BLUE 2 PIN PROGRAMMING/VALET PORT
- F** BLACK 3 PIN ANTENNA PORT
- G** SMART PHONE PORT - For LINKR-LT or TELE-CONNECT Smart Phone Interface modules
- H** NOT USED
- I** BLACK DATA PORTS - For Vehicle Interface Module.
(Fortin & iDataLink protocols supported on both ports - see feature #5)
- J** WHITE 2 PIN LED PORT

OL-HRN-RS-PWR-CST Required

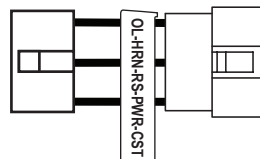

The OL-HRN-RS-PWR-CST re-configures the 6-pin (A) High Current Outputs to be compatible with the Excalibur T-Harness. This adaptor is required for proper operation. In some instances features #4 & #26 will need set to options other than default. In those situations there will be a note indicated the needed settings.

RSX-G5 Installation Steps

INSTALLATION STEPS:

- 1) Go to www.OmegaWeblink.com or use WebLink Mobile to flash the bypass module with the firmware matching the vehicle.
NOTE: iDataLink 2-way protocol is recommended for full functionality.
NOTE: If OEM remote is being used to activate the remote start be sure "Factory keyless RS sequence" is set to "Lock + Lock + Lock" OR "Lock + Unlock + Lock"
NOTE: For Manual Transmission vehicles Feature #11 MUST be set to the desired setting for proper operation.
- 2) Make all the connections shown in the diagram on the following pages.
- 3) Connect any optional hardware as needed.
- 4) Select Data Mode and program the bypass module to the vehicle (see module programming instructions).
- 5) Test the system for all desired functions.

NOTE: Any features NOT supported by the interface module must be hard wired from the remote start to the vehicle. Refer to the remote start install guide and vehicle wiring info at www.wiresheet.com (only available for authorized dealers) for instructions.

MODEL: OL-HRN-RS-HA3

Wire Location Chart Diagram #1

Make	Model	Trim	Year	Adaptor	Item	Connector Color	Connector Pins	Pin #	Wire Color	Polarity	Location
Honda	Accord	Std. Key Automatic	2013-2017	HA3(C)	Parking Lights	WHITE	12	8	GRAY	(-)	Headlight Switch
					Horn	-	-	-	LT. BLUE	(-)	Horn Switch At Top Of Steering Column
Honda	Accord Crosstour	Std. Key SUV Automatic	2013-2015	HA3(C)	Parking Lights	WHITE	12	8	GRAY	(-)	Headlight Switch
					Horn	-	-	-	ORANGE	(-)	Horn Switch At Top Of Steering Column
Honda	Civic	Std. Key Coupe/Sedan Automatic	2012-2013	HA3(C)	Parking Lights	WHITE	12	8	GRAY	(-)	Headlight Switch
					Horn	-	-	-	ORANGE	(-)	Horn Switch At Top Of Steering Column
Honda	Civic	Std. Key Sedan Hybrid Automatic	2012-2013	HA3(C)	Parking Lights	WHITE	12	8	GRAY	(-)	Headlight Switch
					Horn	-	-	-	ORANGE	(-)	Horn Switch At Top Of Steering Column
Honda	Civic	Std. Key Automatic	2014-2015	HA3(C)	Parking Lights	WHITE	12	8	GRAY	(-)	Headlight Switch
					Horn	-	-	-	ORANGE	(-)	Horn Switch At Top Of Steering Column
Honda	Civic	Std. Key Automatic	2016-2021	HA3(C)	Parking Lights	WHITE	12	8	GRAY	(-)	Headlight Switch
					Horn	-	-	-	TAN	(-)	Horn Switch At Top Of Steering Column
Honda	CR-V	Std. Key SUV Automatic	2017-2021	HA3(C)	Parking Lights	WHITE	12	8	GRAY	(-)	Headlight Switch
					Horn	-	-	-	RED	(-)	Horn Switch At Top Of Steering Column
Honda	CR-V	Std. Key SUV Automatic	2012-2016	HA3(C)	Parking Lights	WHITE	12	8	GRAY	(-)	Headlight Switch
					Horn	-	-	-	ORANGE	(-)	Horn Switch At Top Of Steering Column
Honda	Fit	Std. Key 4 Dr Hatchback Automatic	2015-2020	HA3(C)	Parking Lights	WHITE	12	8	GRAY	(-)	Headlight Switch
					Horn	-	-	-	VIOLET	(-)	Horn Switch At Top Of Steering Column
Honda	HR-V	Std. Key SUV Automatic	2016-2021	HA3(C)	Parking Lights	WHITE	12	8	GRAY	(-)	Headlight Switch
					Horn	-	-	-	VIOLET	(-)	Horn Switch At Top Of Steering Column

MODEL: OL-HRN-RS-HA3

RSX-G5 Diagram #1

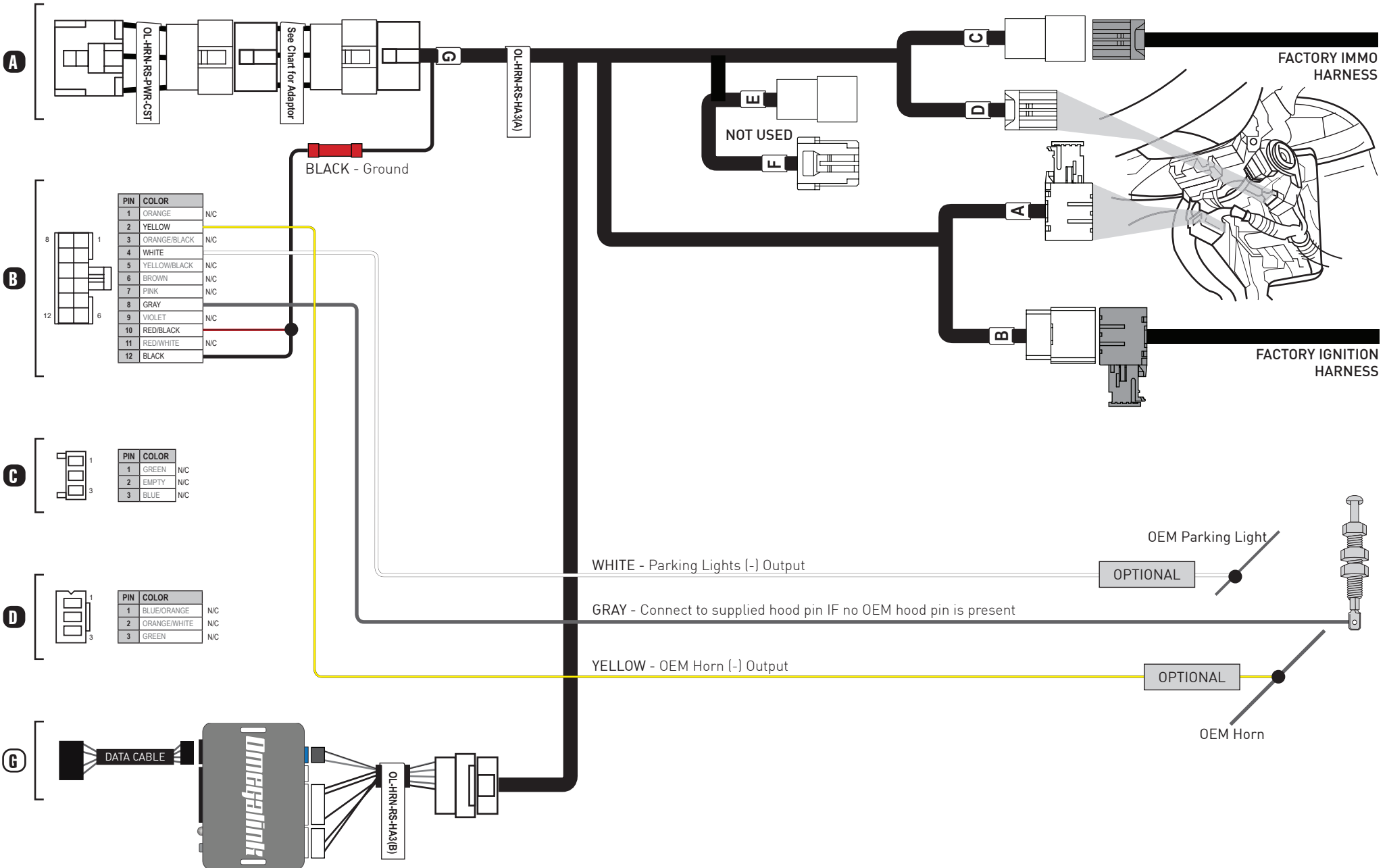

MODEL: OL-HRN-RS-HA3
Wire Location Chart Diagram #2

Make	Model	Trim	Year	Adaptor	Item	Connector Color	Connector Pins	Pin #	Wire Color	Polarity	Location
Acura	TL	Std. Key Sedan Automatic	2009-2014	HA3(D)	Parking Lights	BLACK	12	11	GRAY	(-)	Headlight Switch
					Horn	-	-	-	YELLOW	(-)	Horn Switch At Top Of Steering Column
Acura	TSX	Std. Key Sedan Automatic	2009-2014	HA3(D)	Parking Lights	BLACK	12	11	GRAY	(-)	Headlight Switch
					Horn	-	-	-	GRAY	(-)	Horn Switch At Top Of Steering Column
Acura	TSX	Std. Key Sedan Automatic	2010-2014	HA3(D)	Parking Lights	BLACK	12	11	GRAY	(-)	Headlight Switch
					Horn	-	-	-	GRAY	(-)	Horn Switch At Top Of Steering Column
Acura	TSX	Std. Key Estate/Wagon Automatic	2012-2014	HA3(D)	Parking Lights	BLACK	12	11	GRAY	(-)	Headlight Switch
					Horn	-	-	-	GRAY	(-)	Horn Switch At Top Of Steering Column
Acura	ZDX	Std. Key SUV Automatic	2010-2012	HA3(D)	Parking Lights	BLACK	12	11	WHITE	(-)	Headlight Switch
					Horn	-	-	-	BLUE	(-)	Horn Switch At Top Of Steering Column
Honda	Accord	Std. Key Sedan Automatic	2008-2012	HA3(D)	Parking Lights	BLACK	12	11	GRAY	(-)	Headlight Switch
					Horn	-	-	-	GREEN/YELLOW	(-)	Horn Switch At Top Of Steering Column
Honda	Accord Crosstour	Std. Key SUV Automatic	2010-2012	HA3(D)	Parking Lights	BLACK	12	11	GRAY	(-)	Headlight Switch
					Horn	-	-	-	GRAY	(-)	Headlight Switch
Honda	Odyssey	Std. Key Minivan Automatic	2011-2017	HA3(C)	Parking Lights	BLACK	12	11	GRAY	(-)	Headlight Switch
					Horn	WHITE	20	10	VIOLET	(-)	Horn Switch At Top Of Steering Column
Honda	Pilot	Std. Key SUV Automatic	2009-2015	HA3(D)	Parking Lights	BLACK	12	11	GRAY	(-)	Headlight Switch
					Horn	WHITE	20	1	VIOLET	(-)	Horn Switch At Top Of Steering Column

MODEL: OL-HRN-RS-HA3

RSX-G5 Diagram #2

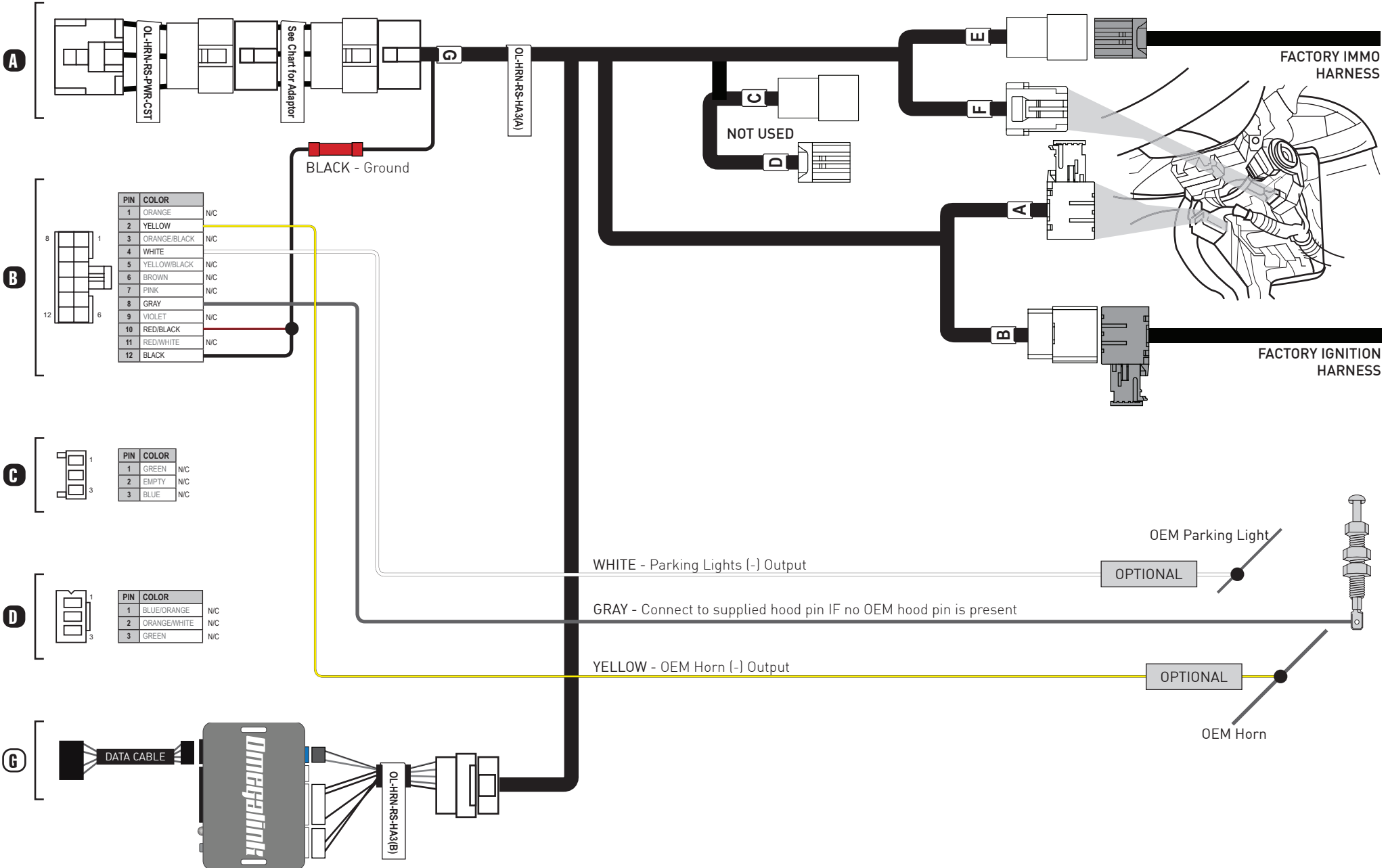

MODEL: OL-HRN-RS-HA3

Wire Location Chart Diagram #3

Make	Model	Trim	Year	Adaptor	Item	Connector Color	Connector Pins	Pin #	Wire Color	Polarity	Location	
Honda	Accord	Std. Key Manual	2013-2017	HA3(C)	Parking Lights	WHITE	12	8	GRAY	(-)	Headlight Switch	
					Horn	-	-	-	LT. BLUE	(-)	Horn Switch At Top Of Steering Column	
					Parking Brake	-	1	1	LT. GREEN	(-)	Parking Brake Switch	
					Clutch Bypass	-	2	2	BROWN	(-)	Clutch Switch	
Honda	Civic	Std. Key Coupe/Sedan Manual	2012-2013	HA3(C)	Parking Lights	WHITE	12	8	GRAY	(-)	Headlight Switch	
					Horn	-	-	-	ORANGE	(-)	Horn Switch At Top Of Steering Column	
					Parking Brake	-	1	1	LT. GREEN	(-)	Parking Brake Switch	
					Clutch Bypass	YELLOW	2	2	ORANGE	(-)	Clutch Switch	
Honda	Civic	Std. Key Manual	2014-2015	HA3(C)	Parking Lights	WHITE	12	8	GRAY	(-)	Headlight Switch	
					Horn	-	-	-	ORANGE	(-)	Horn Switch At Top Of Steering Column	
					Parking Brake	-	1	1	LT. GREEN	(-)	Parking Brake Switch	
					Clutch Bypass	YELLOW	2	2	ORANGE	(-)	Clutch Switch	
Honda	Civic	Std. Key Manual	2016-2021	HA3(C)	Parking Lights	WHITE	12	8	GRAY	(-)	Headlight Switch	
					Horn	-	-	-	TAN	(-)	Horn Switch At Top Of Steering Column	
					Parking Brake	Covered Via Data						
					Clutch Bypass	WHITE	4	4	YELLOW	(-)	Clutch Switch	
Honda	Civic Si	Std. Key Coupe/Sedan Manual	2012-2013	HA3(C)	Parking Lights	WHITE	12	8	GRAY	(-)	Headlight Switch	
					Horn	-	-	-	ORANGE	(-)	Horn Switch At Top Of Steering Column	
					Parking Brake	-	1	1	LT. GREEN	(-)	Parking Brake Switch	
					Clutch Bypass	YELLOW	2	2	ORANGE	(-)	Clutch Switch	
Honda	Fit	Std. Key 4 Dr Hatchback Manual	2015-2020	HA3(C)	Parking Lights	WHITE	12	8	GRAY	(-)	Headlight Switch	
					Horn	-	-	-	VIOLET	(-)	Horn Switch At Top Of Steering Column	
					Parking Brake	-	1	1	BLUE	(-)	Parking Brake Switch	
					Clutch Bypass	-	4	4	LT. GREEN	(-)	Clutch Switch	
Honda	HR-V	Std. Key SUV Manual	2016-2021	HA3(C)	Parking Lights	WHITE	12	8	GRAY	(-)	Headlight Switch	
					Horn	-	-	-	VIOLET	(-)	Horn Switch At Top Of Steering Column	
					Parking Brake	BLUE	40	8	RED	(-)	Dash Fuse Box	
					Clutch Bypass	-	4	4	PINK	(-)	Clutch Switch	

MODEL: OL-HRN-RS-HA3

RSX-G5 Diagram #3

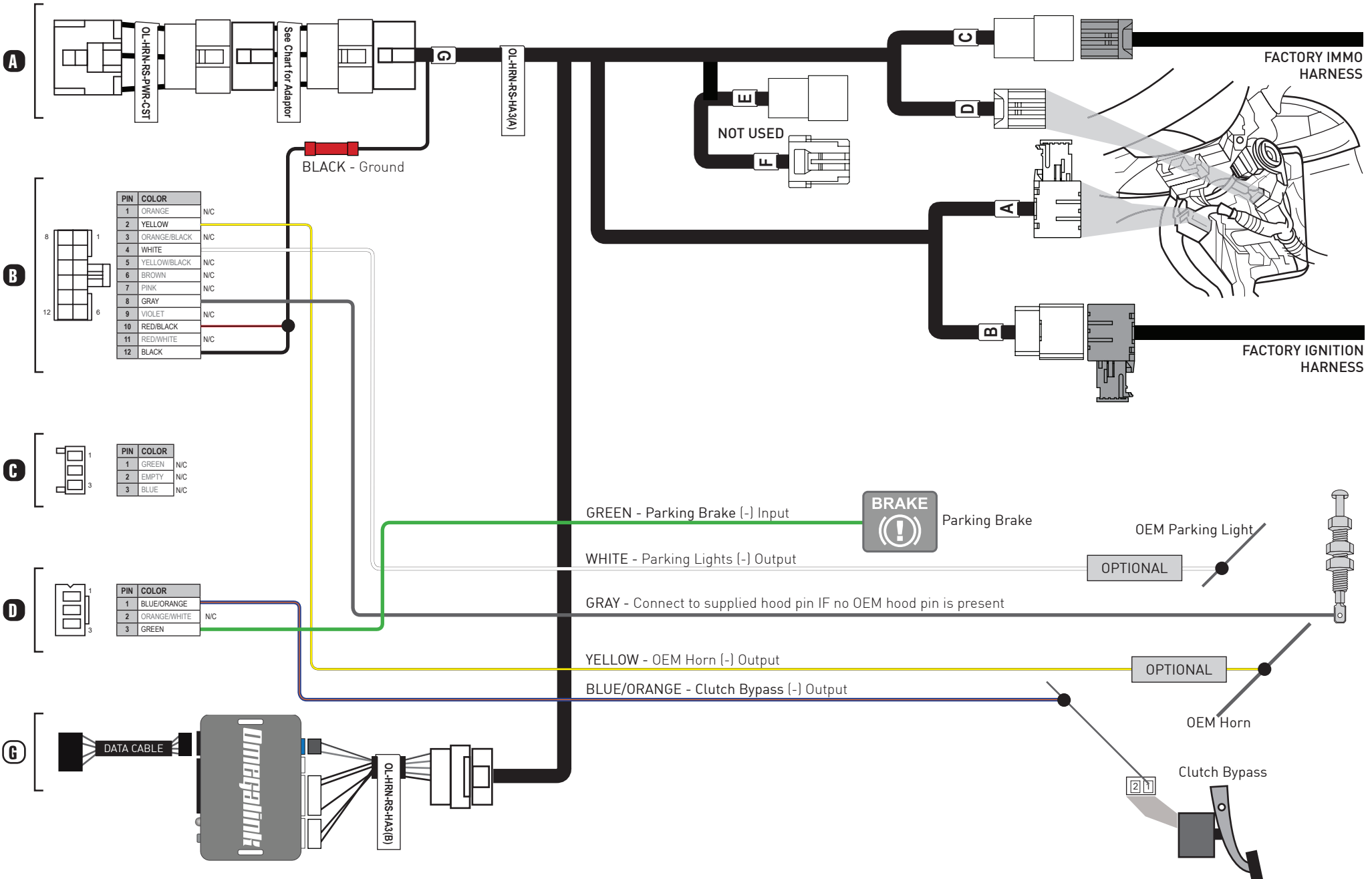

MODEL: OL-HRN-RS-HA3

Wire Location Chart Diagram #4

Make	Model	Trim	Year	Adaptor	Item	Connector Color	Connector Pins	Pin #	Wire Color	Polarity	Location
Acura	TL	Std. Key Sedan Manual	2009-2014	HA3(D)	Parking Lights	BLACK	12	11	GRAY	(-)	Headlight Switch
					Horn	-	-	-	YELLOW	(-)	Horn Switch At Top Of Steering Column
					Parking Brake	WHITE	1	1	LT. GREEN	(-)	Parking Brake Switch
					Clutch Bypass	YELLOW	2	1	PINK	(-)	Clutch Switch
Acura	TSX	Std. Key Sedan Manual	2009-2014	HA3(D)	Parking Lights	BLACK	12	11	GRAY	(-)	Headlight Switch
					Horn	-	-	-	GRAY	(-)	Horn Switch At Top Of Steering Column
					Parking Brake	WHITE	1	1	LT. GREEN	(-)	Parking Brake Switch
					Clutch Bypass	YELLOW	2	1	RED/GREEN	(-)	Clutch Switch
Honda	Accord	Std. Key Coupe/Sedan Manual	2008-2012	HA3(D)	Parking Lights	BLACK	12	11	GRAY	(-)	Headlight Switch
					Horn	-	-	-	GREEN/YELLOW	(-)	Horn Switch At Top Of Steering Column
					Parking Brake	WHITE	1	1	LT. GREEN	(-)	Parking Brake Switch
					Clutch Bypass	YELLOW	2	1	ORANGE	(-)	Clutch Switch

MODEL: OL-HRN-RS-HA3

RSX-G5 Diagram #4

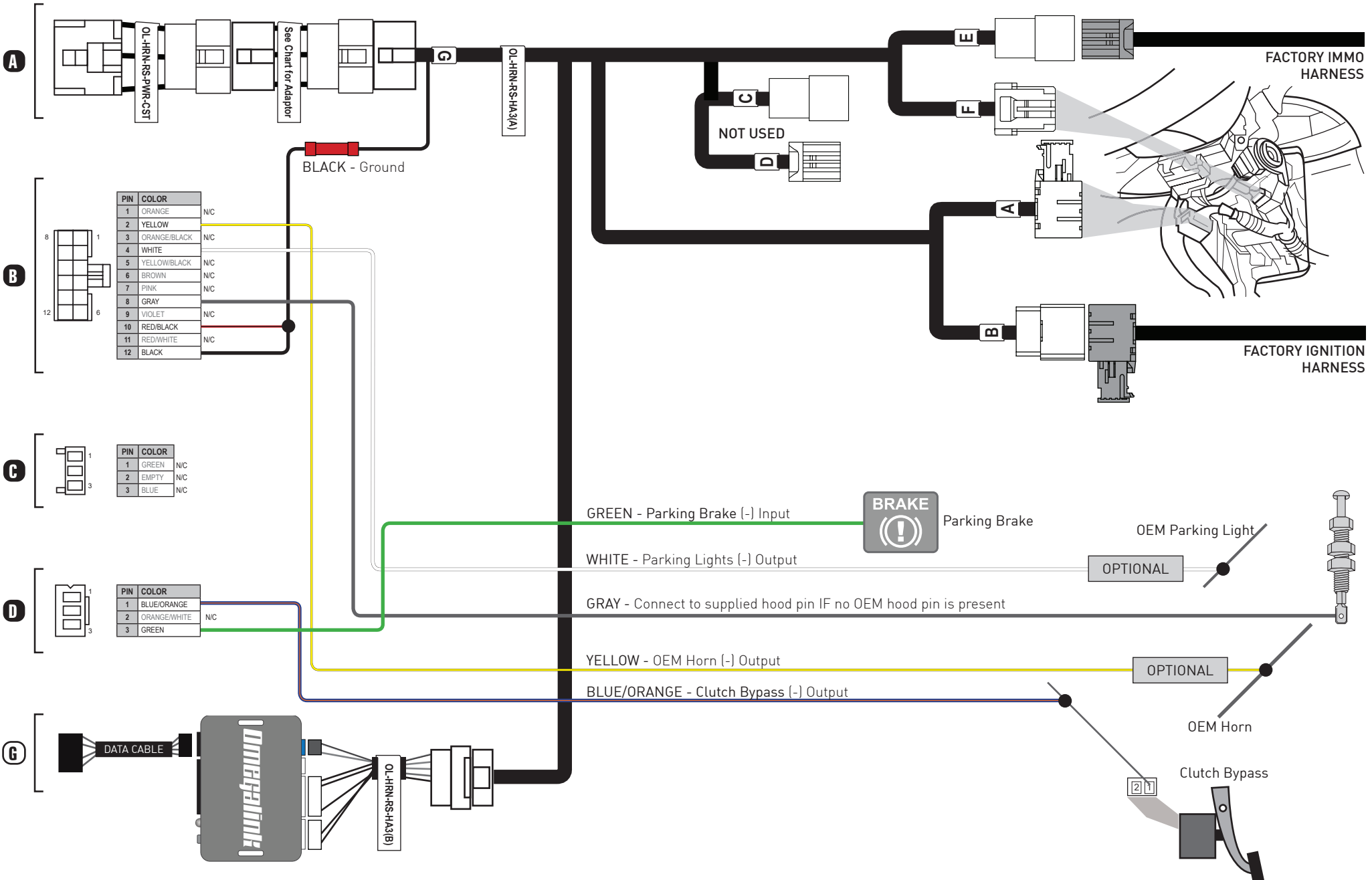

MODEL: OL-HRN-RS-HA3

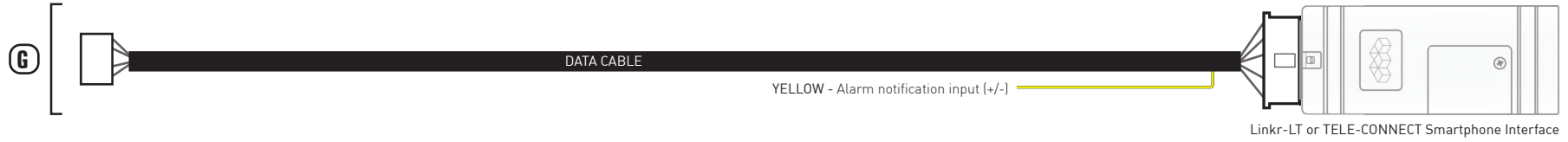

GUIDE ID: CST_HA3_G6_G5_20210419

RSX-G5 Optional Accessories

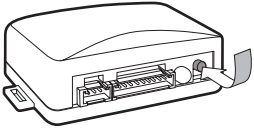

Installation Mode Selection

- 1  Press and release programming button to select installation mode.

 LED flashes (1x) once = Data Mode (Recommended)
 LED flashes (2x) twice = Hardwire Mode

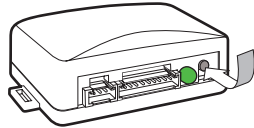
- 2  Press and hold programming button until LED turns solid GREEN to register selection.

! After registration, follow **Factory Reset** to change installation mode and restart this process.

Module Programming

DL-HA3 Firmware Installations

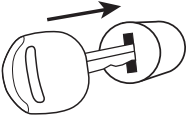
- 1  Insert the key into ignition.

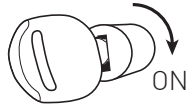
- 2  Turn the key to the ON position.

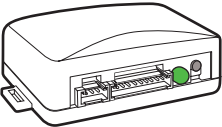
- 3  Wait, LED will turn solid GREEN for 2 seconds.

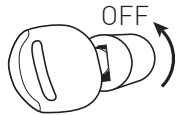
- 4  Turn the key to the OFF position.

- 5  Press UNLOCK on the OEM remote.
 If the vehicle is equipped with a power lift-gate open and Close the power liftgate with the OEM remote.

- 6 Proceed to AL-XX70-B Programming/Vehicle Learn.

DL-HA6 Firmware Installations

- 1  Close driver door.
 Re-open driver door to wake up data bus.

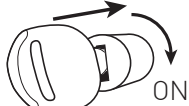
- 2  Insert the key into the ignition and turn to the ON position.

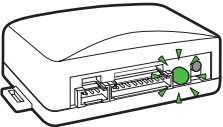
- 3  Wait, the LED will flash GREEN rapidly.

- 4  Turn key to OFF position.

- 5  **WARNING:**
 Disconnect power last
 Disconnect module from vehicle.

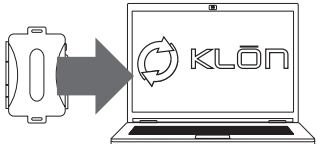
- 6  Connect module to computer and proceed with extended programming.

Module Programming (cont.)

DL-HA6 Firmware Installations (cont.)

- 7**  **WARNING:** Do not press module programming button.
Connect power first.
Connect all other module connectors

- 8**  Turn the key to the ON position.

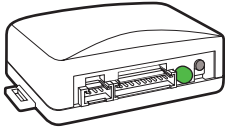
- 9**  Wait, LED will turn solid GREEN for 2 seconds.

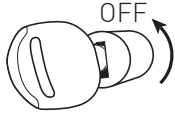
- 10**  Turn the key to the OFF position.

- 11**  Press UNLOCK on the OEM remote.

If the vehicle is equipped with a power lift-gate open and Close the power liftgate with the OEM remote.

- 12** Programming complete. Verify all Remote Start settings and test.

RSX-G6 Layout

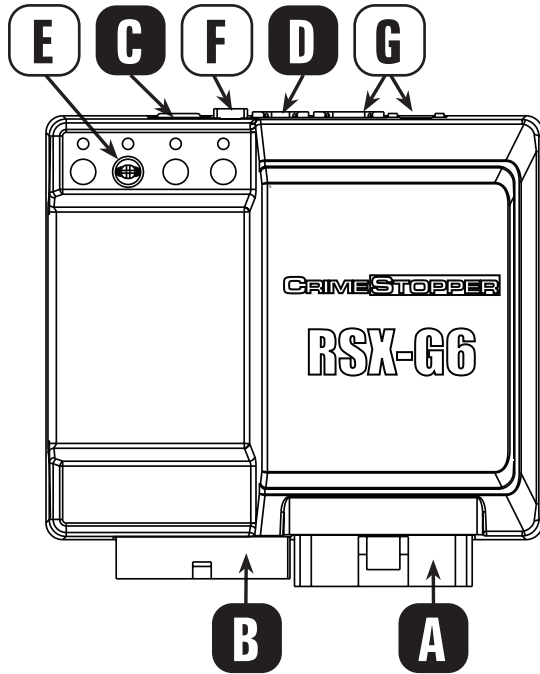

- A** WHITE 6 PIN HIGH CURRENT POWER HARNESS (P/N: H-RS6F*)
- B** WHITE 14 PIN MAIN INPUT/OUTPUT HARNESS (P/N: H-RS14F)
- C** RED 3 PIN DOOR LOCK/UNLOCK HARNESS (P/N: DLP-N3)
- D** RED 3 PIN REMOTE START HARNESS (P/N: H-RS3A)
- E** TEMPERATURE SENSOR - **DO NOT COVER**
(For high/low temp auto start and for automatic low temp crank extender)
- F** ANTENNA / STATUS LIGHT / VALET PORT - Supports compatible plug-in antennas or push-button status light
(P/N: AU-LED-PB2)
- G** GREEN & BLACK DATA PORTS - For Telematics / Data Sensor (Shock, Tilt, etc) / Vehicle Interface Module.
(DBI & iDataLink protocols supported on both ports - see 'Vehicle Learn' or installer feature #12)

RSX-G6 Installation Steps

INSTALLATION STEPS:

- 1) Go to www.OmegaWeblink.com or use WebLink Mobile to flash the bypass module with the firmware matching the vehicle.
NOTE: iDataLink 2-way protocol is recommended for full functionality.
NOTE: If OEM remote is being used to activate the remote start be sure "Factory keyless RS sequence" is set to "Lock + Lock + Lock" OR "Lock + Unlock + Lock"
- 2) Make all the connections shown in the diagram on the following pages.
- 3) Connect any optional hardware as needed.
- 4) Select Data Mode and program the bypass module to the vehicle (see module programming instructions).
- 5) Perform Vehicle Learn to configure the remote start to match the vehicle.
NOTE: If Vehicle Learn is not performed remote start operation could fail.
- 6) Test the system for all desired functions.

NOTE: Any features NOT supported by the interface module must be hard wired from the remote start to the vehicle. Refer to the remote start install guide and vehicle wiring info at www.wiresheet.com (only available for authorized dealers) for instructions.

MODEL: OL-HRN-RS-HA3

Wire Location Chart Diagram #1

Make	Model	Trim	Year	Adaptor	Item	Connector Color	Connector Pins	Pin #	Wire Color	Polarity	Location
Honda	Accord	Std. Key Automatic	2013-2017	HA3(C)	Parking Lights	WHITE	12	8	GRAY	(-)	Headlight Switch
					Horn	-	-	-	LT. BLUE	(-)	Horn Switch At Top Of Steering Column
Honda	Accord Crosstour	Std. Key SUV Automatic	2013-2015	HA3(C)	Parking Lights	WHITE	12	8	GRAY	(-)	Headlight Switch
					Horn	-	-	-	ORANGE	(-)	Horn Switch At Top Of Steering Column
Honda	Civic	Std. Key Coupe/Sedan Automatic	2012-2013	HA3(C)	Parking Lights	WHITE	12	8	GRAY	(-)	Headlight Switch
					Horn	-	-	-	ORANGE	(-)	Horn Switch At Top Of Steering Column
Honda	Civic	Std. Key Sedan Hybrid Automatic	2012-2013	HA3(C)	Parking Lights	WHITE	12	8	GRAY	(-)	Headlight Switch
					Horn	-	-	-	ORANGE	(-)	Horn Switch At Top Of Steering Column
Honda	Civic	Std. Key Automatic	2014-2015	HA3(C)	Parking Lights	WHITE	12	8	GRAY	(-)	Headlight Switch
					Horn	-	-	-	ORANGE	(-)	Horn Switch At Top Of Steering Column
Honda	Civic	Std. Key Automatic	2016-2021	HA3(C)	Parking Lights	WHITE	12	8	GRAY	(-)	Headlight Switch
					Horn	-	-	-	TAN	(-)	Horn Switch At Top Of Steering Column
Honda	CR-V	Std. Key SUV Automatic	2017-2021	HA3(C)	Parking Lights	WHITE	12	8	GRAY	(-)	Headlight Switch
					Horn	-	-	-	RED	(-)	Horn Switch At Top Of Steering Column
Honda	CR-V	Std. Key SUV Automatic	2012-2016	HA3(C)	Parking Lights	WHITE	12	8	GRAY	(-)	Headlight Switch
					Horn	-	-	-	ORANGE	(-)	Horn Switch At Top Of Steering Column
Honda	Fit	Std. Key 4 Dr Hatchback Automatic	2015-2020	HA3(C)	Parking Lights	WHITE	12	8	GRAY	(-)	Headlight Switch
					Horn	-	-	-	VIOLET	(-)	Horn Switch At Top Of Steering Column
Honda	HR-V	Std. Key SUV Automatic	2016-2021	HA3(C)	Parking Lights	WHITE	12	8	GRAY	(-)	Headlight Switch
					Horn	-	-	-	VIOLET	(-)	Horn Switch At Top Of Steering Column

RSX-G6 Diagram #1

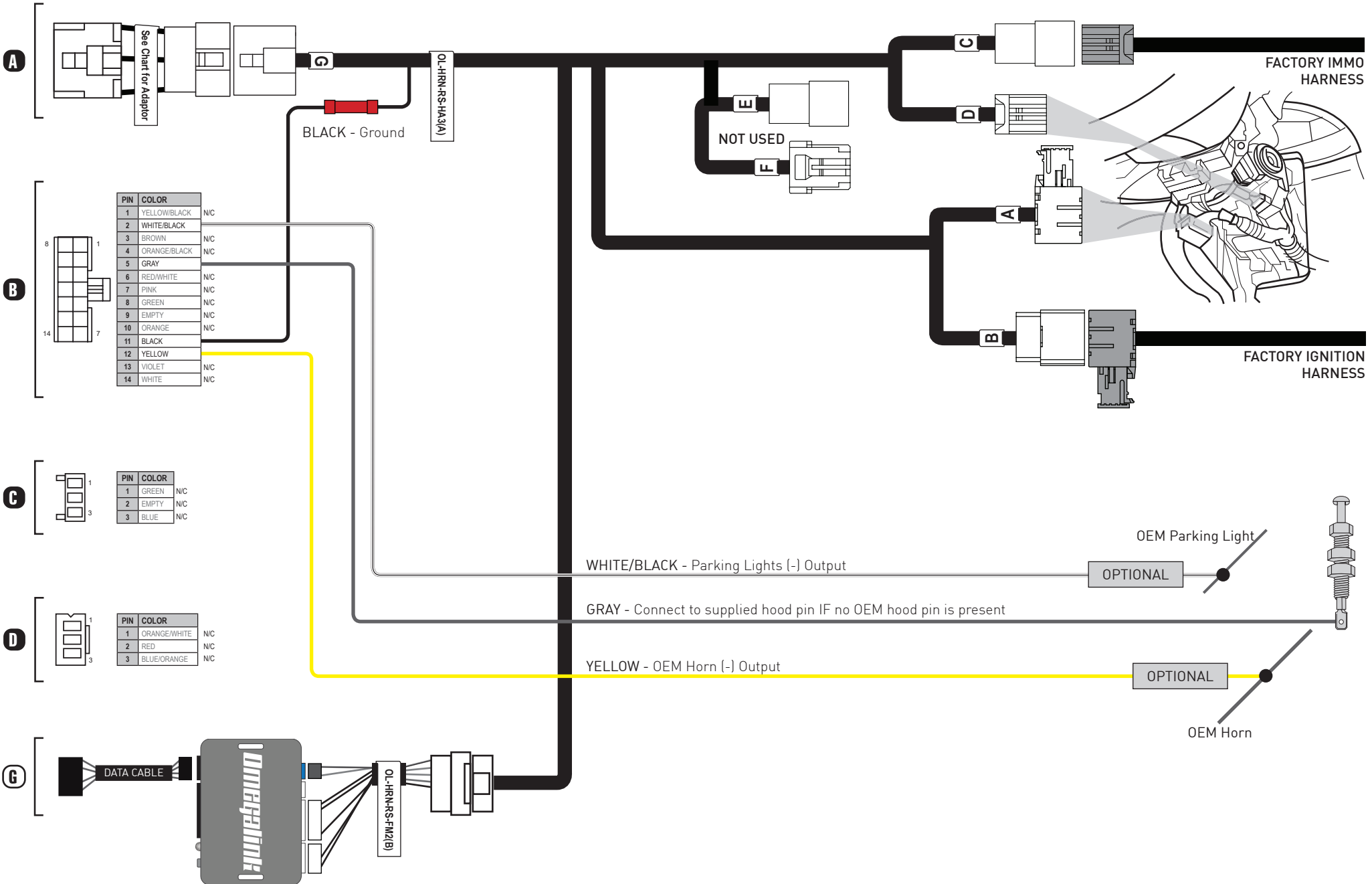

MODEL: OL-HRN-RS-HA3

Wire Location Chart Diagram #2

Make	Model	Trim	Year	Adaptor	Item	Connector Color	Connector Pins	Pin #	Wire Color	Polarity	Location
Acura	TL	Std. Key Sedan Automatic	2009-2014	HA3(D)	Parking Lights	BLACK	12	11	GRAY	(-)	Headlight Switch
					Horn	-	-	-	YELLOW	(-)	Horn Switch At Top Of Steering Column
Acura	TSX	Std. Key Sedan Automatic	2009-2014	HA3(D)	Parking Lights	BLACK	12	11	GRAY	(-)	Headlight Switch
					Horn	-	-	-	GRAY	(-)	Horn Switch At Top Of Steering Column
Acura	TSX	Std. Key Sedan Automatic	2010-2014	HA3(D)	Parking Lights	BLACK	12	11	GRAY	(-)	Headlight Switch
					Horn	-	-	-	GRAY	(-)	Horn Switch At Top Of Steering Column
Acura	TSX	Std. Key Estate/Wagon Automatic	2012-2014	HA3(D)	Parking Lights	BLACK	12	11	GRAY	(-)	Headlight Switch
					Horn	-	-	-	GRAY	(-)	Horn Switch At Top Of Steering Column
Acura	ZDX	Std. Key SUV Automatic	2010-2012	HA3(D)	Parking Lights	BLACK	12	11	WHITE	(-)	Headlight Switch
					Horn	-	-	-	BLUE	(-)	Horn Switch At Top Of Steering Column
Honda	Accord	Std. Key Sedan Automatic	2008-2012	HA3(D)	Parking Lights	BLACK	12	11	GRAY	(-)	Headlight Switch
					Horn	-	-	-	GREEN/YELLOW	(-)	Horn Switch At Top Of Steering Column
Honda	Accord Crosstour	Std. Key SUV Automatic	2010-2012	HA3(D)	Parking Lights	BLACK	12	11	GRAY	(-)	Headlight Switch
					Horn	-	-	-	GRAY	(-)	Headlight Switch
Honda	Odyssey	Std. Key Minivan Automatic	2011-2017	HA3(C)	Parking Lights	BLACK	12	11	GRAY	(-)	Headlight Switch
					Horn	WHITE	20	10	VIOLET	(-)	Horn Switch At Top Of Steering Column
Honda	Pilot	Std. Key SUV Automatic	2009-2015	HA3(D)	Parking Lights	BLACK	12	11	GRAY	(-)	Headlight Switch
					Horn	WHITE	20	1	VIOLET	(-)	Horn Switch At Top Of Steering Column

RSX-G6 Diagram #2

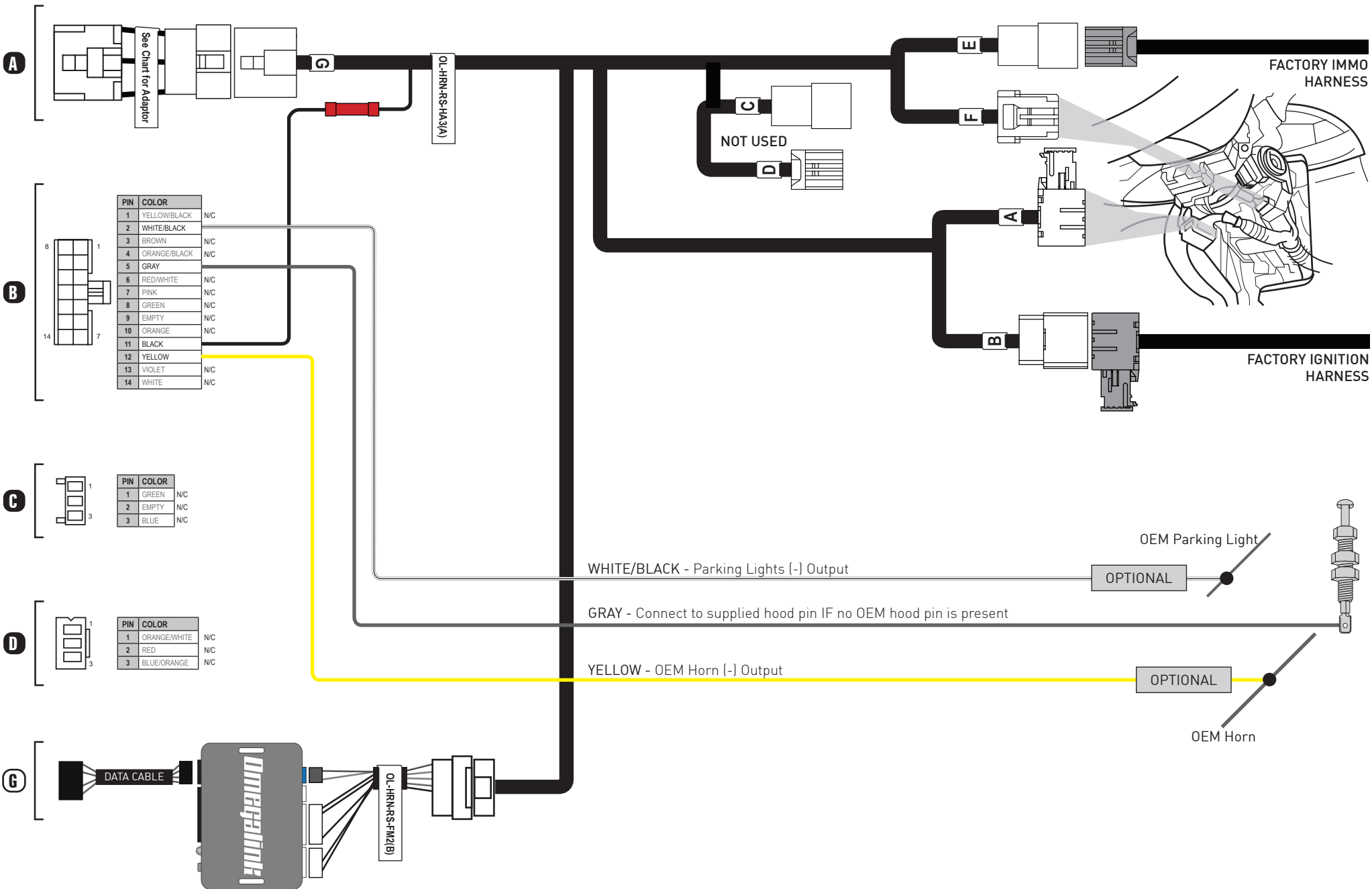

MODEL: OL-HRN-RS-HA3

Wire Location Chart Diagram #3

Make	Model	Trim	Year	Adaptor	Item	Connector Color	Connector Pins	Pin #	Wire Color	Polarity	Location	
Honda	Accord	Std. Key Manual	2013-2017	HA3(C)	Parking Lights	WHITE	12	8	GRAY	(-)	Headlight Switch	
					Horn	-	-	-	LT. BLUE	(-)	Horn Switch At Top Of Steering Column	
					Parking Brake	-	1	1	LT. GREEN	(-)	Parking Brake Switch	
					Clutch Bypass	-	2	2	BROWN	(-)	Clutch Switch	
Honda	Civic	Std. Key Coupe/Sedan Manual	2012-2013	HA3(C)	Parking Lights	WHITE	12	8	GRAY	(-)	Headlight Switch	
					Horn	-	-	-	ORANGE	(-)	Horn Switch At Top Of Steering Column	
					Parking Brake	-	1	1	LT. GREEN	(-)	Parking Brake Switch	
					Clutch Bypass	YELLOW	2	2	ORANGE	(-)	Clutch Switch	
Honda	Civic	Std. Key Manual	2014-2015	HA3(C)	Parking Lights	WHITE	12	8	GRAY	(-)	Headlight Switch	
					Horn	-	-	-	ORANGE	(-)	Horn Switch At Top Of Steering Column	
					Parking Brake	-	1	1	LT. GREEN	(-)	Parking Brake Switch	
					Clutch Bypass	YELLOW	2	2	ORANGE	(-)	Clutch Switch	
Honda	Civic	Std. Key Manual	2016-2021	HA3(C)	Parking Lights	WHITE	12	8	GRAY	(-)	Headlight Switch	
					Horn	-	-	-	TAN	(-)	Horn Switch At Top Of Steering Column	
					Parking Brake	Covered Via Data						
					Clutch Bypass	WHITE	4	4	YELLOW	(-)	Clutch Switch	
Honda	Civic Si	Std. Key Coupe/Sedan Manual	2012-2013	HA3(C)	Parking Lights	WHITE	12	8	GRAY	(-)	Headlight Switch	
					Horn	-	-	-	ORANGE	(-)	Horn Switch At Top Of Steering Column	
					Parking Brake	-	1	1	LT. GREEN	(-)	Parking Brake Switch	
					Clutch Bypass	YELLOW	2	2	ORANGE	(-)	Clutch Switch	
Honda	Fit	Std. Key 4 Dr Hatchback Manual	2015-2020	HA3(C)	Parking Lights	WHITE	12	8	GRAY	(-)	Headlight Switch	
					Horn	-	-	-	VIOLET	(-)	Horn Switch At Top Of Steering Column	
					Parking Brake	-	1	1	BLUE	(-)	Parking Brake Switch	
					Clutch Bypass	-	4	4	LT. GREEN	(-)	Clutch Switch	
Honda	HR-V	Std. Key SUV Manual	2016-2021	HA3(C)	Parking Lights	WHITE	12	8	GRAY	(-)	Headlight Switch	
					Horn	-	-	-	VIOLET	(-)	Horn Switch At Top Of Steering Column	
					Parking Brake	BLUE	40	8	RED	(-)	Dash Fuse Box	
					Clutch Bypass	-	4	4	PINK	(-)	Clutch Switch	

MODEL: OL-HRN-RS-HA3

RSX-G6 Diagram #3

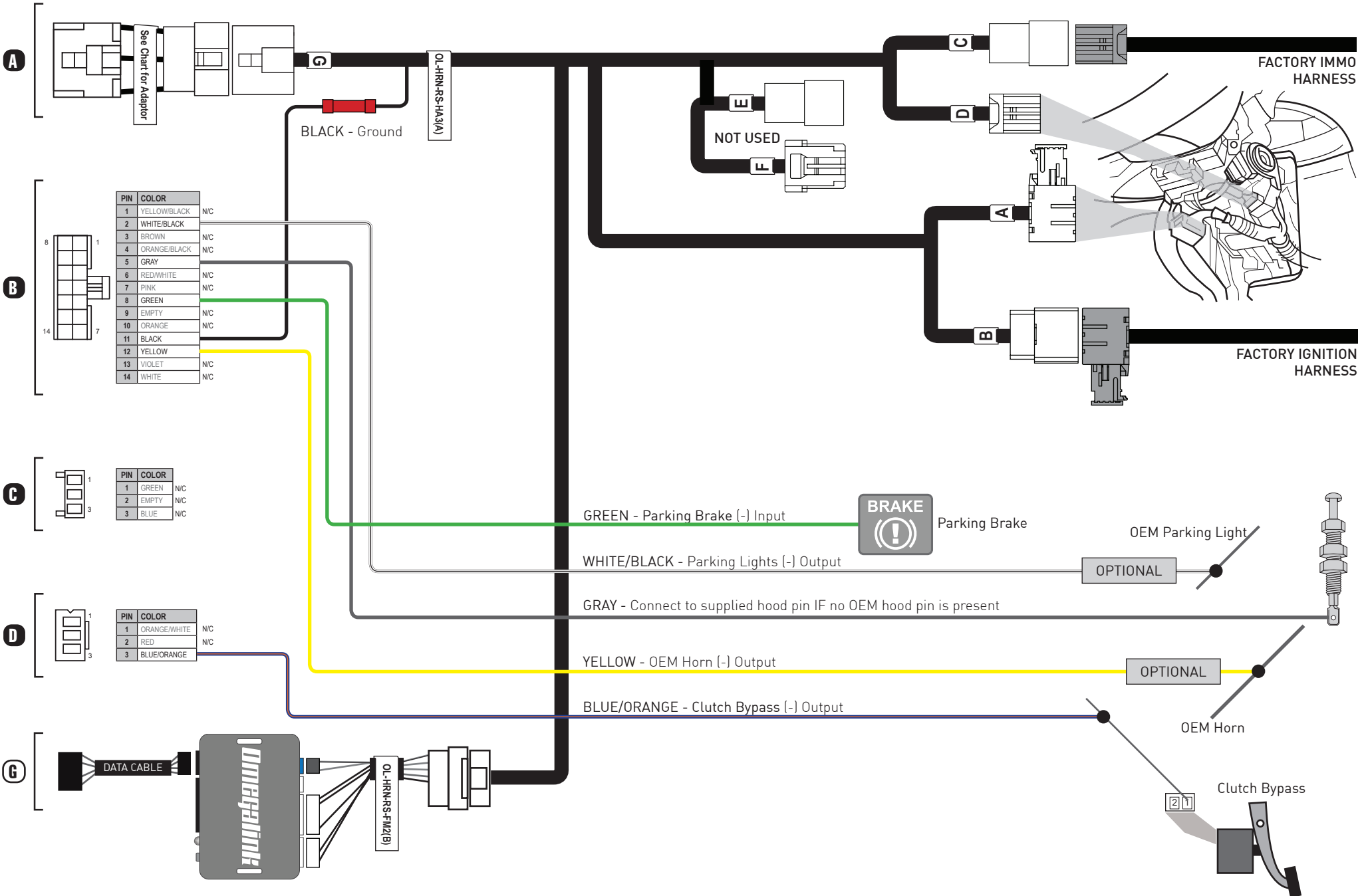

MODEL: OL-HRN-RS-HA3

Wire Location Chart Diagram #4

Make	Model	Trim	Year	Adaptor	Item	Connector Color	Connector Pins	Pin #	Wire Color	Polarity	Location
Acura	TL	Std. Key Sedan Manual	2009-2014	HA3(D)	Parking Lights	BLACK	12	11	GRAY	(-)	Headlight Switch
					Horn	-	-	-	YELLOW	(-)	Horn Switch At Top Of Steering Column
					Parking Brake	WHITE	1	1	LT. GREEN	(-)	Parking Brake Switch
					Clutch Bypass	YELLOW	2	1	PINK	(-)	Clutch Switch
Acura	TSX	Std. Key Sedan Manual	2009-2014	HA3(D)	Parking Lights	BLACK	12	11	GRAY	(-)	Headlight Switch
					Horn	-	-	-	GRAY	(-)	Horn Switch At Top Of Steering Column
					Parking Brake	WHITE	1	1	LT. GREEN	(-)	Parking Brake Switch
					Clutch Bypass	YELLOW	2	1	RED/GREEN	(-)	Clutch Switch
Honda	Accord	Std. Key Coupe/Sedan Manual	2008-2012	HA3(D)	Parking Lights	BLACK	12	11	GRAY	(-)	Headlight Switch
					Horn	-	-	-	GREEN/YELLOW	(-)	Horn Switch At Top Of Steering Column
					Parking Brake	WHITE	1	1	LT. GREEN	(-)	Parking Brake Switch
					Clutch Bypass	YELLOW	2	1	ORANGE	(-)	Clutch Switch

RSX-G6 Diagram #4

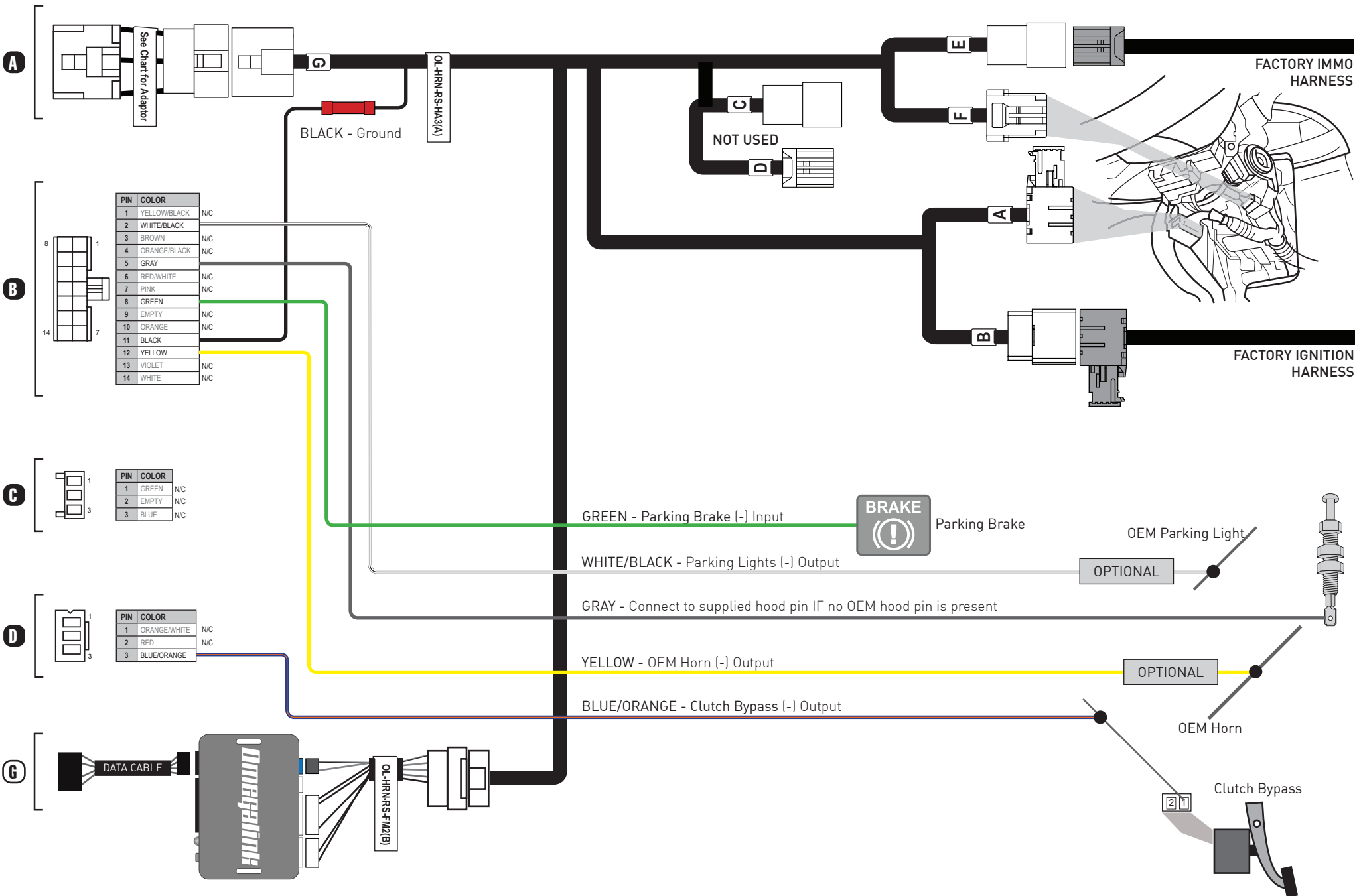

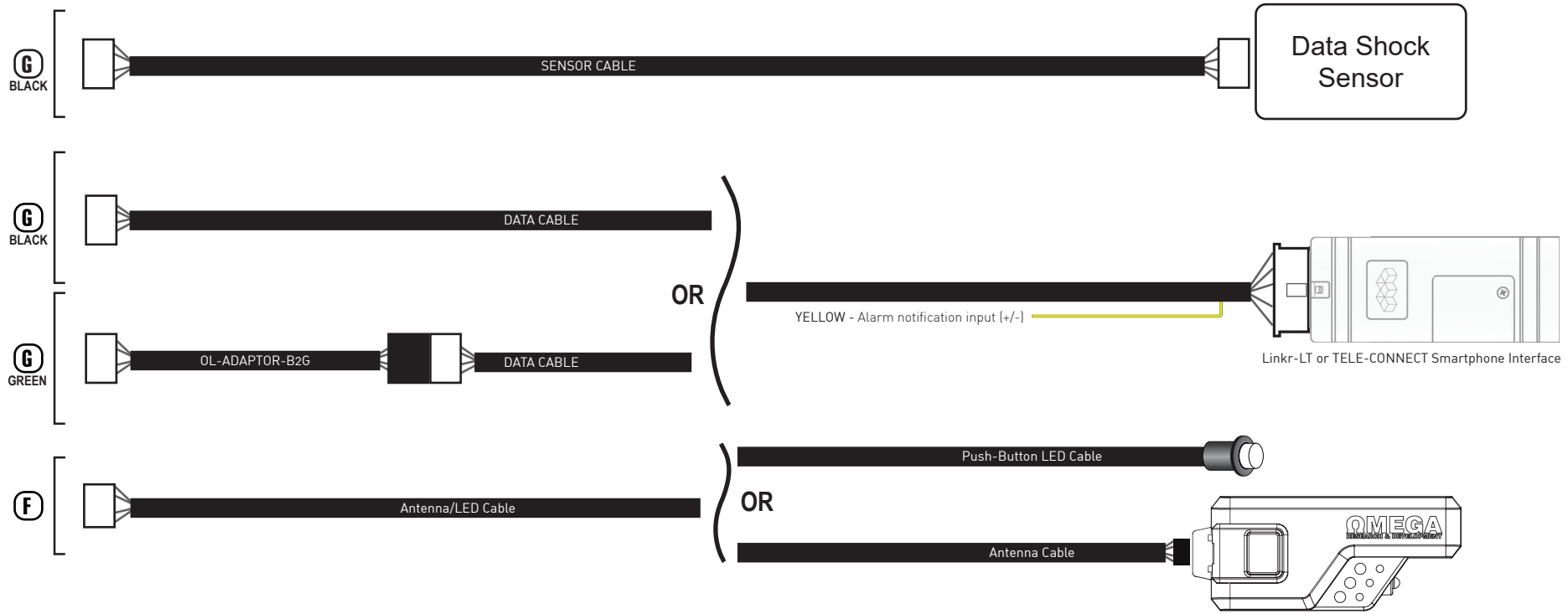

RSX-G6 Optional Accessories

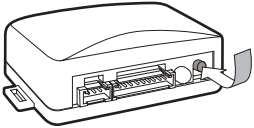

Installation Mode Selection

- 1  Press and release programming button to select installation mode.

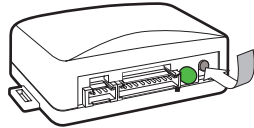

 LED flashes (1x) once = Data Mode (Recommended)
 LED flashes (2x) twice = Hardwire Mode

- 2  Press and hold programming button until LED turns solid GREEN to register selection.



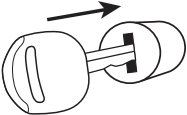
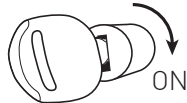
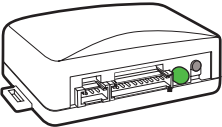
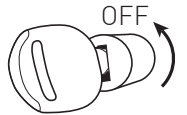

! After registration, follow Factory Reset to change installation mode and restart this process.

Module Programming

DL-HA3 Firmware Installations



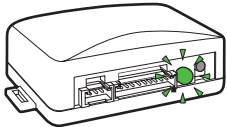
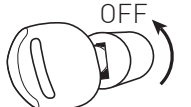

-  Insert the key into ignition.
-  Turn the key to the ON position.
-  Wait, LED will turn solid GREEN for 2 seconds.
-  Turn the key to the OFF position.
-  Press UNLOCK on the OEM remote.
 If the vehicle is equipped with a power lift-gate open and Close the power liftgate with the OEM remote.
- Proceed to AL-XX70-B Programming/Vehicle Learn.

DL-HA6 Firmware Installations

-  Close driver door.
 Re-open driver door to wake up data bus.
-  Insert the key into the ignition and turn to the ON position.
-  Wait, the LED will flash GREEN rapidly.
-  Turn key to OFF position.
-  **WARNING:**
 Disconnect power last
 Disconnect module from vehicle.
-  Connect module to computer and proceed with extended programming.

Module Programming (cont.)

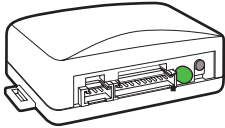
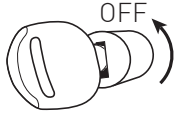
DL-HA6 Firmware Installations (cont.)

- | | | |
|----|--|--|
| 7 |  | <p>WARNING: Do not press module programming button.
Connect power first.
Connect all other module connectors</p> |
| 8 |  | <p>Turn the key to the ON position.</p> |
| 9 |  | <p>Wait, LED will turn solid GREEN for 2 seconds.</p> |
| 10 |  | <p>Turn the key to the OFF position.</p> |
| 11 |  | <p>Press UNLOCK on the OEM remote.

If the vehicle is equipped with a power lift-gate open and Close the power liftgate with the OEM remote.</p> |
| 12 | | <p>Proceed to RSX-G6 Programming/Vehicle Learn.</p> |

RSX-G6 Programming/Vehicle Learn

Before You Begin:

- Make sure all wires/harnesses are connected.
- Program the bypass module to the vehicle per the instructions on the previous pages.
- Connect any additional accessories/modules to the data ports.
- **MANUAL TRANSMISSION VEHICLES ONLY:** Change feature #6 to desired setup process. Connect the GREEN wire to the vehicles parking brake and set the parking brake.

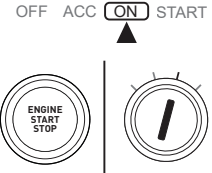
1 OFF ACC **ON** START
 Turn ignition to ON position (do not start).

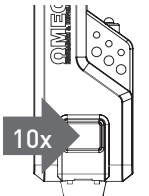
2
 Press the Valet button 8x within 10 seconds

- The system will chirp & flash lights to indicate crank delay (Default: 1 chirp/flash = 1.5 sec)
- **Optional:** Press valet button to change crank delay- Chirps: 1=1.5 sec, 2=15 sec, 3=20 sec, 4=30 sec

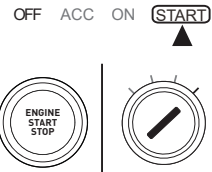
3 OFF ACC ON **START**
 Start the engine with the key and let the engine reach normal idle.

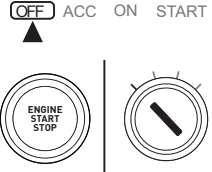
4 OFF ACC ON START
 **AUTOMATIC TRANSMISSIONS:**
 Turn the ignition key OFF.
 - The system will chirp & flash the lights equal the # of IGN/ACC/START circuits detected (Max: 4).
MANUAL TRANSMISSIONS:
 Release the parking brake.
 - The system will chirp & flash the lights equal the # of IGN/ACC/START circuits detected (Max: 4).
 Set the parking brake again.
 Before turning the key OFF, perform the selected MT rerevation sequence (feature #6)

5
 **PUSH-BUTTON-START VEHICLES:**
 Exit the vehicle and take the OEM fob/key 20 feet away to allow remote start.

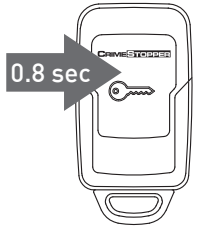
6
 Activate remote start (feature #16) within 60 sec. Wait until engine is running and LED flashes slowly (10-45 seconds after engine cranks & runs).

- The system will detect data protocols, select the best available engine running detection method, and, learn any available tach input (data or analog).

7
 **TO SAVE SETTINGS/FINISH VEHICLE LEARN:**
 Press the BRAKE pedal (will shut down RS).

- This disables VEHICLE LEARN (to enable again, program installer feature #2 (bank 10) to "Enabled").

TO CANCEL/START OVER:
 Press the valet button once.

8 Programming complete.

Troubleshooting

- See system installation guide for remote start diagnostics and troubleshooting.
- See OmegaLink module/firmware guide at www.wiresheet.com for interface module diagnostics and troubleshooting.